

**THE WORLD'S STRONGEST  
AND SAFEST QUICK RELEASE  
BUCKLES AND MORE  
MADE IN AUSTRIA**



# COMPONENTS



# AUSTRIALPIN WORKBOOK

# 2024

THE WORLD'S STRONGEST  
AND SAFEST QUICK RELEASE  
BUCKLES AND MORE  
MADE IN AUSTRIA

# AUSTRIALPIN.AT

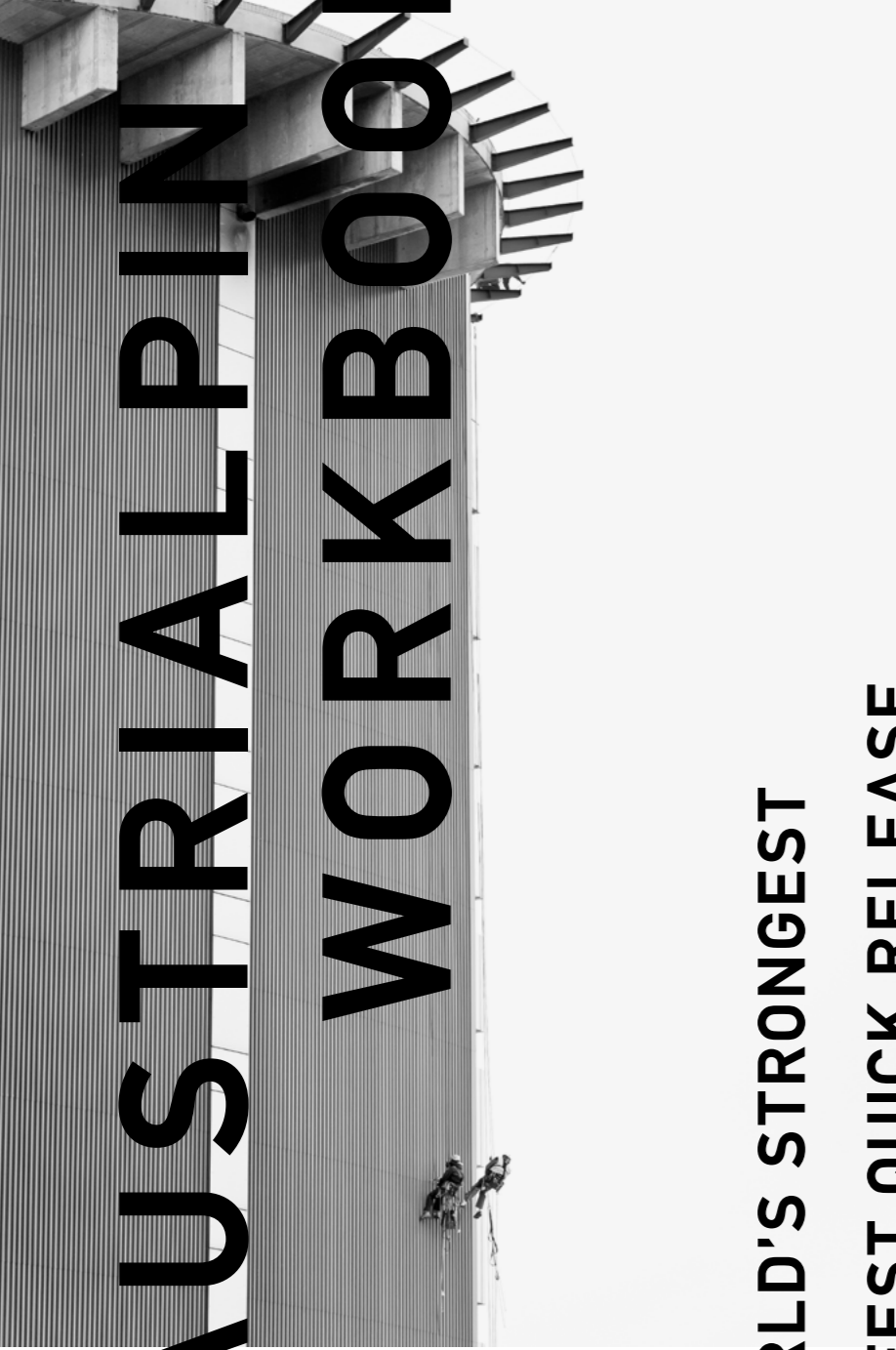

# COMPONENTS

# EDITORIAL KOMponentEN EDITORIAL COMPONENTS

photocredit: Klaus Kranebitter



















Was macht man, wenn man die stärkste und sicherste Schnalle der Welt entwickelt und erfolgreich auf den Markt gebracht hat? Richtig! Man tüftelt, forscht und entwickelt weiter! Stillstand war und ist für uns bei AUSTRIALPIN keine Option, und so legen wir uns die Latte jedes Jahr ein Stückchen höher, um die hohe Qualität unserer COBRA®-Schnallen noch weiter zu verbessern und ihr den nötigen Feinschliff zu verpassen. Mit dem höchsten Anspruch an Qualität wurde im Stubaital also auch dieses Mal wieder geträumt, geplant, überdacht, gearbeitet und produziert – mit viel Herzblut und Erfolg! So sind wir stolz, dieses Jahr unsere innovative neue Beschichtung, das High Performance Coating (HPC), präsentieren zu können. Besonders widerstandsfähig, abriebfest, hitzebeständig und voller Farbvielfalt wird die AUSTRIALPIN-Innovation ab sofort die Pulverbeschichtung ersetzen. Ebenso verabschieden wir uns in Zukunft von unserer COBRA® THE ORIGINAL Schnalle und freuen uns über seinen High-End-Nachfolger, die COBRA® PRO STYLE. Und weil auf unseren Lorbeeren ausruhen so gar nicht unser Ding ist, möchten wir für die stärkste und sicherste Schnalle der Welt auch weiterhin den Fokus auf Forschung und Entwicklung legen. Weil nur perfekt gut genug für uns ist. #dominategravity

What to do when you developed and successfully launched the strongest and safest buckle in the world? Right! You go on with more research and development! Standing still has never been an option for us at AUSTRIALPIN, this is why every year, we set the bar higher to improve the quality of our COBRA® buckles even more and to give them their fine-tuning. With the highest quality claim, also this time we dreamt, planned, revised, worked and produced in Stubaital valley – with a lot of life blood and success! This year we proudly present our new innovative coating, the High Performance Coating (HPC). This AUSTRIALPIN innovation is especially resistant, abrasion-proof, heat-proof, offers a wide range of colors and will, from now on, replace the powder coating. In addition, we will say goodbye to our COBRA® THE ORIGINAL buckle in the future and are happy to welcome its high-end successor, the COBRA® PRO STYLE. And because resting on our laurels is just not how we roll, also in the future our focus for the strongest and safest buckle in the world will be on research and development. Because only perfect is good enough for us. #dominategravity

—  
Katrin Mark-Winkler  
General Manager



# ICONS AND INDEX

	<b>Bruchkraft Umreifung</b> Breaking load loop configuration	<b>Schnalle und Gurtband als Einheit geprüft</b> Buckle and textile element tested as a unit Kilonewton [kN]
18 kN		
	<b>Bruchkraft gerader Zug</b> Breaking load tensile strength	<b>Bruchlastwertermittlung auf geraden Zug</b> Buckle is tested with tensile strength Kilonewton [kN]
18 kN		
	<b>Bruchkraft D-Ring</b> Breaking load D-ring	<b>Bruchlastwertermittlung auf geraden Zug</b> D-ring is tested with tensile strength Kilonewton [kN]
	<b>Material</b> Material	<b>Materialangabe</b> Indication of material
Aluminium		
		
Polymer		
		
Steel		
		
Stainless Steel		
	<b>Internationale Normen</b> International standards	<b>CEN: Comité Européen de Normalisation</b> UIAA: Union Internationale des Associations d'Alpinisme <b>ANSI: American National Standards Institute</b> <b>CSA: Canadian Standards Association</b> <b>NFPA: National Fire Protection Association</b>
		
		
	<b>Offshore</b> Offshore	<b>100 % seawassertauglich</b> 100 % offshore suitable
	<b>Gewicht</b> Weight	<b>Gewicht in Gramm [g]</b> Weight in gram [g]
72 g		
	<b>Maße</b> Measurements	<b>Größenangabe in Millimeter [mm], Zentimeter [cm] oder Meter [m]</b> Indication of size in millimeter [mm], centimeter [cm] or meter [m]
100/66 mm		
	<b>Keine PSA</b> No PPE	<b>Keine persönliche Sicherheitsausrüstung</b> No personal protective equipment
	<b>Made in</b> Made in	<b>Herstellungsland</b> Country of origin
	<b>Neu</b> New	<b>Anzeige neuer Produkte</b> Indication of new products

## INTRODUCTION P 8

### COBRA® QUICK RELEASE P 18

- COBRA® NG P 20
- COBRA® PRO STYLE P 36
- COBRA® PRO STYLE SNAKEBITE P 38
- COBRA® PRO STYLE 18 KN P 40
- D-RING COBRA® PRO STYLE 18 KN P 41
- COBRA® PRO STYLE RETROFIT 18 KN P 42
- SUPER COBRA® P 43
- COBRA® NAUTIC P 44
- COBRA® FM P 46
- GT COBRA® P 48
- COBRA® OUL P 50
- COBRA® SPECIAL DESIGNS P 52

### THREAD BACK BUCKLES AND RINGS P 54

- COBRAFRAME P 58
- RINGS P 62
- SLIDEBLOC AND BELT BUCKLES P 66

### PRODUCTS EXTRACT P 70

- CARABINER EXTRACT P 80
- AIR SPORTS CARABINERS AND PULLEYS P 92
- BELAY AND RAPPEL DEVICE EXTRACT P 94
- RIGGING PLATES P 98
- CORDS AND SLINGS EXTRACT P 100
- FASHION P 102

# WOFÜR WIR STEHEN

## QUALITY MADE IN AUSTRIA

### DER SPEZIALIST IN SACHEN SICHERHEIT

#### THE SAFETY SPECIALIST

Seit mehr als 25 Jahren konzentrieren wir uns auf unsere Kernkompetenz: die Metallverarbeitung. Neben der weltweit sichersten Schnalle stellen wir noch weitere innovative Produkte für den taktischen Bereich und die Arbeitssicherheit her. Der Fokus liegt dabei immer auf essentiellen Produkten, die das Leben ihrer Anwender sicherer machen und durch herausragende Qualität „Made in Austria“ überzeugen. For more than 25 years, we have been focusing on our core competence: metal processing. Besides the world's strongest buckle, we also manufacture a selection of innovative products for the tactical and work safety industry. Thereby, our focus is on essential products which make their users' lives safer and convince with their high "Made in Austria" quality.

### SICHERHEIT & QUALITÄT UNSERER PRODUKTE SIND DAS A UND O

#### SAFETY AND QUALITY OF OUR PRODUCTS ARE IMPORTANT TO US

Deshalb produzieren wir da, wo wir die volle Kontrolle über unsere Prozesse haben: vor unserer Haustür in Fulpmes, einem kleinen Ort im Stubaital, Österreich. Wir investieren ständig in die Forschung und Entwicklung, neue Maschinen und ein herausragendes Qualitätsmanagement, um unsere Produkte zu den sichersten der Welt zu machen. This is why we produce where we have full control over all processes: in front of our doorstep in Fulpmes, a small town in Stubaital valley, Austria. We constantly invest in research and development, new machines and a great quality management to make our products the safest worldwide.



photocredit: Josef Wittibschlager



photocredit: Josef Wittibschlager

### VERANTWORTUNG FÜR UNSERE GESELLSCHAFT

#### RESPONSIBILITY TO SOCIETY

Wir glauben, dass es unsere Verantwortung gegenüber der Gesellschaft ist, möglichst lokal zu produzieren. Damit sagen wir „Nein“ zu langen Lieferketten, kreieren Jobs in der Region und sorgen somit für größtmögliche Nachhaltigkeit. We believe that it is our responsibility to society to manufacture as locally as possible. With our production site in Fulpmes, we say no to long supply chains, create jobs on site and this way provide for the highest sustainability possible.

### HOHE UMWELTAUFLAGEN? ABER BITTE GERNE!

#### STRICT ENVIRONMENTAL REGULATIONS? YES PLEASE!

Als Produzent der stärksten und sichersten Schnalle der Welt ist es nicht nur unsere Verantwortung Menschen zu schützen, sondern auch unseren Lebensraum und die Natur. Mit unserer Produktion in Europa sorgen wir für eine umweltfreundliche Herstellung unserer Produkte, verzichten auf lange Transportwege und halten so unseren ökologischen Fußabdruck so gering wie möglich. As the producer of the strongest and safest buckle worldwide it is not only our responsibility to protect peoples lives – it is also our responsibility to protect Mama nature and treat her with respect. This is why we put emphasis on an eco-friendly production and short delivery distances. This way, we keep our ecological footprint to a minimum.



photocredit: Josef Wittibschlager

### SERVICE TRIFFT AUF LEIDENSCHAFT

#### SERVICE MEETS PASSION

Fragen? Anregungen? Kritik? Bei uns seid ihr definitiv richtig! Unser gesamtes Team ist, ebenso wie die Produktion, in Fulpmes stationiert und immer für euch da, um Fragen zu beantworten, weiterzuhelfen und eure Wünsche in die Realität umzusetzen. Do you have questions? Ideas? Criticism? Then you are right here! Our whole team is located in Fulpmes and always ready to answer your questions, to help you out and to make your wishes become reality.

# UNSERE VERANTWORTUNG: EURE SICHERHEIT OUR RESPONSIBILITY: YOUR SAFETY



Für die Sicherheit unserer Kunden scheuen wir keine Mühen. Deshalb ist unser Qualitätsmanagement eines, das den höchsten Anforderungen entspricht und seinesgleichen sucht. Um die Zuverlässigkeit und Qualität unserer Produkte zu gewährleisten, durchlaufen diese vorab mehrere Tests – hier wird nichts dem Zufall überlassen. To us, the safety of our customers is a top priority and we put every effort into making our products the best and safest mankind has ever seen. This is why our quality management sets a standard unparalleled in this industry. Our products go through several tests, so we can guarantee their superior reliability.



## WARENEINGANGSKONTROLLE INCOMING INSPECTION

Wir unterziehen unser Material einer optischen und Maßkontrolle sowie einer Härteprüfung. Durch die Vergabe von Chargennummern können Fehler immer sofort zurückverfolgt werden. Our material undergoes an optical and a dimensional check as well as a hardness test. By using batch numbers, errors can be tracked back immediately.



## PRÜFRUNDEN INSPECTION PLAN

Mindestens einmal täglich werden die Frästeile von jeder Maschine einer Funktions- und Sicherheitskontrolle unterzogen. At least once a day, milled parts of every machine undergo a function check and a safety control.



## ZUGKONTROLLE TENSILE STRENGTH TEST

Von jeder Charge werden Stichproben einer Zugkontrolle mit und ohne Gurt unterzogen. Dabei werden sie 3 Minuten der maximalen Zugkraft ausgesetzt. Samples of every batch undergo a tensile strength test with and without belt. Thereby, they are exposed to the maximum tensile strength for 3 minutes.



## ENDKONTROLLE FINAL INSPECTION AND TESTING

Jede COBRA® Schnalle wird mehrmals per Hand auf ihre Funktion überprüft. Zusätzlich überprüft eine optische Maschine die korrekte Vernietung der Schnallen. Every COBRA® buckle is tested for its function by hand multiple times. In addition an optical scanning machine checks the correct riveting of each buckle.



## WARENAUSGANGSKONTROLLE OUTGOING GOODS INSPECTION

Vor dem Versand kontrolliert ein Mitarbeiter stichprobenartig die fertigen Schnallen optisch und auf ihre Funktion. Before shipping, an employee tests samples of the finished buckles optically and for their function.

# COBRA® KOMPONENTEN ANWENDUNGEN COBRA® COMPONENTS APPLICATIONS

## YOU CAN ALWAYS #RELYONCOBRA

COBRA® Schnallen werden überall dort eingesetzt, wo es um Sicherheit für Mensch und Material geht. Gurthersteller rund um den Globus vertrauen auf die zuverlässige Komponente. So vielfältig die COBRA® Schnallen sind, so breit gefächert sind auch ihre Einsatzbereiche – sie kommt im taktischen Bereich ebenso zum Einsatz wie im Rettungswesen, der Absturzsicherung und in der Mode. The COBRA® Quick Release buckle is the benchmark when it comes to safety of men and material. Manufacturers around the globe trust in the COBRA® components which are available in many different models and are constantly revised and improved. Because of their diversity they are used in a wide range of fields – in the tactical sector, for rescue services and fall protection as well as in the fashion industry.



01 Die D-RING COBRAFRAME 18 kN EASY RELEASE im Einsatz bei der Feuerwehr. D-RING COBRA FRAME 18 kN EASY RELEASE used by fire fighters.



02 Die COBRA® PRO STYLE zur Sicherung der Rennfahrer bei Stockcar-Rennen. COBRA® PRO STYLE used for stock car racing.

03 Diverse COBRA® Schnallen an Schutzwesten und Gürteln. Several COBRA® buckles used on plate carriers and other tactical products.

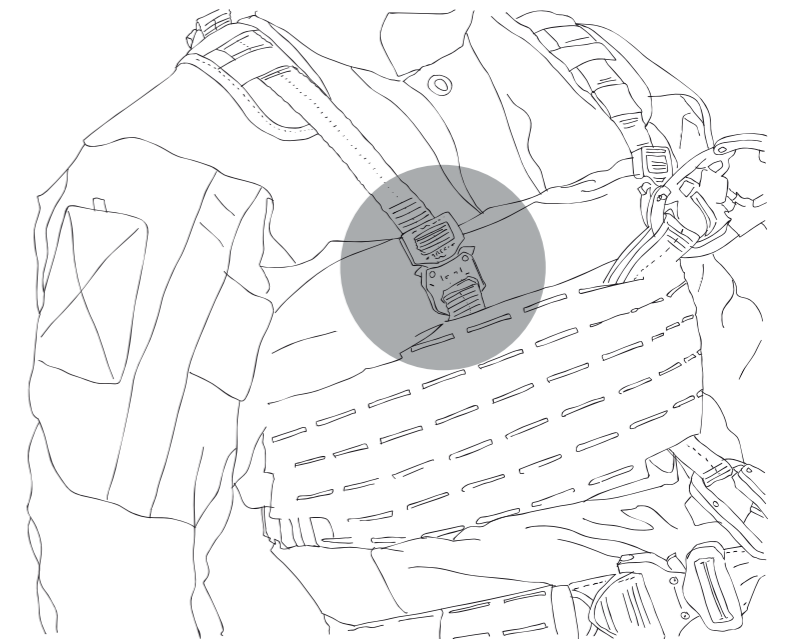

04 D-RING COBRA® PRO STYLE 18 kN an Hundehalsbändern und -geschirr. D-RING COBRA® PRO STYLE 18 kN on dog collars and harnesses.



# BESCHICHTUNGEN COATINGS

## MOST COMMON COBRA® FINISHES

Mindestbestellmenge:  
200 Stk.

Minimum order  
quantity: 200 pcs.



**KTL STANDARD  
COATING (K)**



**POLISHED  
(A)**

## ANODIZED

Mindestbestellmenge:  
500 Stk. Weitere  
Farben auf Anfrage.

Minimum order  
quantity: 500 pcs.

Other colors on  
request.



**MATTE BLACK  
BLACK CLIPS (M)**



**AZURE BLUE  
ANODIZED (B)**



**LIGHT GREEN  
ANODIZED (N)**



**RED  
ANODIZED (R)**

## HIGH PERFOR- MANCE COATING (HPC)

Mindestbestellmenge:

500 Stk. Weitere

Farben auf Anfrage.

Minimum order  
quantity: 500 pcs.

Other colors on  
request.



**COYOTE BROWN  
(C)**



**WOLF GREY  
(E)**



**FOLIAGE GREEN  
(F)**



**ELEPHANT GREY  
(G)**



**OLIVE GREEN  
(L)**



**BROWN GREY  
(Q)**



**DESERT SAND  
(S)**



**TAN 499  
(T)**

## HARD COATED

Mindestbestellmenge:

500 Stk.

Minimum order  
quantity: 500 pcs.



**HARD COAT  
(H)**



Die Mindestbestellmengen kann variieren und wird je nach Modell auf volle Verpackungseinheiten aufgerundet. Farben auf Anfrage haben abweichende Mindestbestellmengen. The minimum order quantity may vary and is rounded up to full packaging units depending on the model. Colors on request have different minimum order quantities.



# THE NEW HIGH PERFORMANCE COATING (HPC)

## VORTEILE BENEFITS

Einsätze unter rauesten Bedingungen sind das tägliche Brot der COBRA® Komponenten. Verbaut in den unterschiedlichsten Systemen, müssen sie härtesten Anforderungen standhalten. Das neue, vollautomatische Verfahren zur Oberflächenbeschichtung, „High Performance Coating“ (HPC), ist eine Eigenentwicklung von AUSTRIALPIN. Komponenten mit HPC bieten eine ausgezeichnete Abriebfestigkeit gepaart mit sehr hoher Widerstandsfähigkeit. Das HPC ermöglicht es, glänzende, aber auch matte Oberflächen zu erzeugen, welche ihre Vorzüge besonders im taktischen und sicherheitstechnischen Bereich ausspielen. Farbtreue und -homogenität inklusive!

Performing in the harshest conditions is just daily routine for the COBRA® components. Used in a vast array of environments, systems and applications, they must be ready to meet the toughest requirements. The AUSTRIALPIN research department has developed a new and fully automated method of surface coating. The "High Performance Coating" (HPC) offers exceptional resistance to wear and abrasion and is highly durable. HPC gives us the opportunity to make shiny and matte finished surfaces. Last one is especially beneficial for all tactical and safety components. It is consistent, true to color and highly homogeneous.

MADE IN AUSTRIA



**STRONGER. BETTER. HIGHLY RESISTANT.  
100% IN-HOUSE PRODUCTION.**

## HPC EVOLUTION HPC EVOLUTION



**D-RING COBRA®  
PRO STYLE 18 KN  
WITH HPC**

FALL 2018

Die erste Komponente, die von der neuen Oberflächenbeschichtung „HPC“ profitierte, war die D-RING COBRA® PRO STYLE 18 kN. Das Finish des schwarzmatte D-Rings wird seit Herbst 2018 mit dem High Performance Coating ausgeliefert. The D-RING COBRA® PRO STYLE 18 kN was the first component benefiting from the new surface coating method. Since fall 2018, the finish of the D-ring has come with the matte black High Performance Coating.



**COBRA®  
PRO STYLE  
WITH HPC**

SPRING 2019

Die erste Schnalle mit kompletter High Performance Beschichtung war die COBRA® PRO STYLE (45 mm). Seitdem wird die Beschichtung stetig auf weitere COBRA® Modelle ausgeweitet. The COBRA® PRO STYLE (45 mm) was the first fully HPC-covered buckle. Since then, we've consistently extended the range of COBRA® models with HPC and in various colors.

TO BE  
CONTINUED  
...

COBRA® NG QUICK RELEASE  
COBRA® NG QUICK RELEASE



GRAB  
THE  
COBRA

### COBRA® NG QUICK RELEASE

Mit Triple Lock für noch mehr Sicherheit.  
With Triple Lock for even more safety.

Gefertigt aus hochfestem Polymer.  
Made from high-strength polymer.

Maximale Kompatibilität innerhalb der COBRA® NG Familie.  
Maximum compatibility within the COBRA® NG family.



GRAB THE COBRA  
AND ORDER NOW!

# COBRA® NG QUICK RELEASE FEATURES

NEW

## FUNKTIONALITÄT FUNCTIONALITY



Die neue COBRA® NG QUICK RELEASE ist eine Sicherheitschnalle, die mit einem neuartigen Triple Lock System ausgestattet ist. Sie besteht aus hochfestem Polymer und wird im Spritzgussverfahren hergestellt. Dank ihrer Konstruktionsweise ist sie besonders robust und widerstandsfähig. Die Schnalle ermöglicht ein müheloses Einrasten von Schub- und Hauptteil. Dies wird durch das typische "Klick"-Geräusch bestätigt. Ein Lösen unter Spannung ist praktisch unmöglich. The brandnew COBRA® NG QUICK RELEASE is a safety buckle equipped with an innovative Triple Lock System. It is manufactured from high-strength polymer in an injection molding process. Its special design makes it extremely robust and resilient. The locking mechanism makes an accidental opening of the buckle nearly impossible and is confirmed by a distinct "clicking" sound. A release under tension is impossible.

## TRIPLE LOCK FEATURES TRIPLE LOCK FEATURES



CLIPS ZUSAMMEN DRÜCKEN  
SQUEEZE BOTH CLIPS



SCHNALLE ZUSAMMENSCHIEBEN  
PRESS THE BUCKLE



SCHNALLE NACH OBEN HEBEN  
LIFT THE BUCKLE UPWARDS

## FORMSCHLUSS FORM FIT

Schub- und Hauptteil der COBRA® NG greifen formschlüssig ineinander, dadurch ist der Verschlussmechanismus nicht lasttragend. Male and female part of the COBRA® NG interlock positively. This makes the locking mechanism non-load bearing and extra strong.



## KOMPATIBILITÄT COMPATIBILITY

Genießen Sie maximale Flexibilität mit unserem COBRA® NG QUICK RELEASE-System. Innerhalb der NG-Familie kann jedes Schub- mit jedem Hauptteil kombiniert werden. Enjoy maximum flexibility with our COBRA® NG QUICK RELEASE system. You can combine any male part with any female part within the NG family.

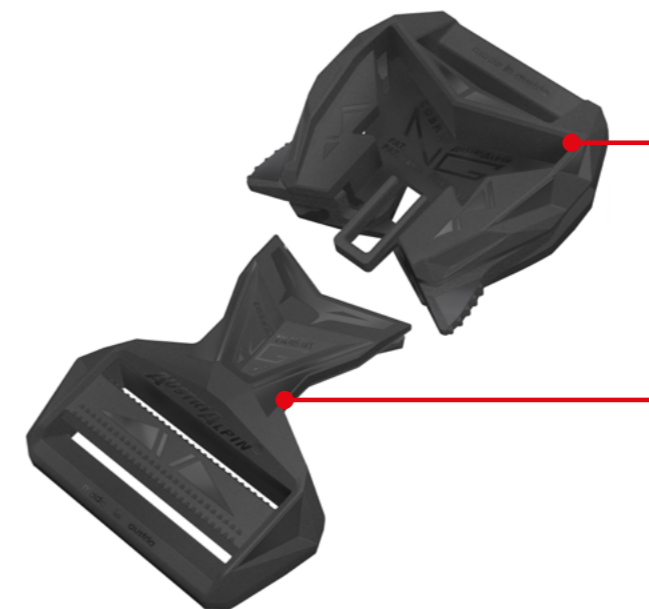

Das Hauptteil der Schnalle bietet keine Verstellmöglichkeit und wird mit dem Gurtband fix vernäht. On the non-adjustable female part, the webbing needs to be sewn in.

Beim Schubteil der Schnalle kann dank des Verstellsteiges die Länge des Gurtbandes individuell und schnell angepasst werden. The adjuster bar on the male part of the buckle lets you adjust the webbing length.



HYBRID – Kombination aus 45 mm Schub- und 25 mm Hauptteil  
HYBRID – combination of 45 mm male and 25 mm female part



25 mm Schub- und Hauptteil  
25 mm male and female part



HYBRID - Kombination aus 25 mm Schub- und 45 mm Hauptteil  
HYBRID – combination of 25 mm male and 45 mm female part

# COBRA® NG QUICK RELEASE



## COBRA® NG QUICK RELEASE

Verfügbar in Halnteilen. Innerhalb der COBRA® NG-Familie kann jedes Schub- mit jedem Hauptteil kombiniert werden. Die COBRA® NG ist nicht PSA-zertifiziert.

Available as half parts. All sizes and variants of the COBRA® NG are compatible. The COBRA® NG is not PPE-certified.

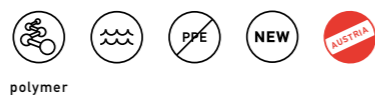

polymer

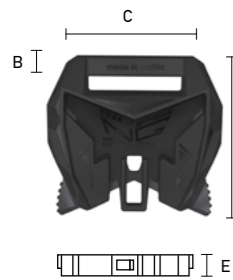

FN..WF-**						
mm	A	B	C	D	E	
25	-	4	47	42	16	13
45	-	4	61	45	18	17

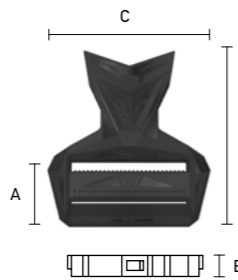

FN..MT-*						
mm	A	B	C	D	E	
25	13	-	42	59	19	12
45	16	-	64	69	19	18

## COBRA® NG CODE GENERATOR

COBRA® BUCKLE	TYPE	WEBBING	PART	SLOT	COLOR	CLIP COLOR (ONLY FOR FEMALE PART)	
<u>F</u>	<u>N</u>	<u>45</u>	<u>M</u>	<u>T</u>	<u>-</u>	<u>M</u>	
F	N NG	25 mm 1"	M male	T tri-glide, adjustable	-	M black matte	M matte black
		45 mm 1.75"	W female	F non-adjustable			G grey

# COBRA® QUICK RELEASE COBRA® QUICK RELEASE

MADE IN  
AUSTRIA



## COBRA® PRO STYLE

**Patentierter Schließmechanismus verhindert ungewolltes Öffnen.**  
Patented locking mechanism prevents unwanted opening.

**Gefertigt aus hochwertigem Aluminium.**  
Made from high-quality aluminium.

**Kompatibel mit anderen COBRA® PRO STYLE Modellen.**  
Compatible with other COBRA® PRO STYLE versions.



# COBRA® FEATURES

## FUNKTIONALITÄT FUNCTIONALITY

Die COBRA® Quick Release ist eine Schnalle, die den höchsten Anforderungen an Sicherheit für ihre Anwender entspricht, da sie nur durch gleichzeitiges Drücken beider Clips geöffnet werden kann. Ein Öffnen unter Last ist bei allen COBRA® Quick Release Schnallen (ausgenommen aller „Open Under Load“-Modelle) nicht möglich. Sie erlauben ein müheloses Einrasten von Schub- und Hauptteil. Dieses wird durch das typische „Klick“-Geräusch bestätigt. Ein einseitiges Einrasten ist nahezu unmöglich. The COBRA® Quick Release is a buckle which meets the highest safety requirements. The buckle can only be opened by pressing both clips at the same time. The locking is confirmed by a distinct “clicking” sound. This mechanism makes one-sided locking and opening under load of the buckle (except of our “Open Under Load” models) nearly impossible.



### 1. OPEN

Durch Drücken beider Clips wird die COBRA® geöffnet. Press both clips to open the COBRA®.

### 2. OPEN

Einseitiges Öffnen nahezu unmöglich. Ein Öffnen unter Last ist nahezu unmöglich. One-sided relieve is nearly impossible. A relieve under tension is impossible.

### 3. CLOSE

Einseitiges Einrasten ist nahezu unmöglich. Das Schließen wird akustisch durch ein „Klick“-Geräusch bestätigt. One-sided locking is nearly impossible. Locking is confirmed by “clicking” sound.

## GRÖSSEN- VERGLEICH SIZE COMPARISON

Abbildungen im Verhältnis. Die Millimeter-Angabe bezieht sich auf die passende Gurtbreite. Sizes are in relation and no original sizes. Indication of mm/inches refers to the webbing width.



Recomm. webbing width  
25 mm 1"



Recomm. webbing width  
33 mm 1 1/4"



Recomm. webbing width  
38 mm 1 1/2"



Recomm. webbing width  
45 mm 1 3/4"



Recomm. webbing width  
50 mm 2"



Recomm. webbing width  
58 mm 2 1/4"

## KOMPATIBILITÄT COMPATIBILITY

Alle COBRA® Typen sind in unterschiedlichen Breiten, jeweils angepasst an die gängigen Gurtbreiten, erhältlich. Innerhalb jeden Typs (z.B. PRO STYLE oder COBRA® PRO STYLE 18 kN) sind alle Größen (25–58 mm) und Varianten (verstellbar, fix) der Haupt- und Schussteile kompatibel. All COBRA® models are available in different standard sizes. All COBRA® Quick Releases within the same type (e.g. PRO STYLE and COBRA® PRO STYLE 18 kN) can be combined with all sizes (25–58 mm) and variants (adjustable, non-adjustable) of the male and female part.



# MIX THE COBRA® ANY WAY YOU LIKE. THE BREAKING LOAD ALWAYS STAYS THE SAME!



FEMALE PART ADJUSTABLE



FEMALE PART NON-ADJUSTABLE



MALE PART NON-ADJUSTABLE



MALE PART ADJUSTABLE

25 mm 1"    33 mm 1 1/4"    38 mm 1 1/2"    45 mm 1 3/4"    50 mm 2"    58 mm 2 1/4"

## CLIPS COLORS & SIZES



STANDARD SIZE BRASS



STANDARD SIZE BLACK (-B)



XL SIZE BRASS (-XL)



XL SIZE BLACK (-XB)

## DIE MARKIERUNGEN EINER COBRA® THE MARKINGS OF A COBRA®

Die Markierungen einer COBRA® erklärt am Beispiel einer COBRA® PRO STYLE. Die Markierungen können sich je nach Modell unterscheiden. The markings of a COBRA® buckle explained on a COBRA® PRO STYLE. The markings can differ depending on the COBRA® model.



- 1 TYP TYPE
- 2 PATENT PATENT
- 3 BRUCHLAST SCHNALLE IN KILONEWTON gerader Zug BREAKING LOAD IN KILONEWTON tensile strength
- 4 BRUCHLAST SCHNALLE IN KILONEWTON in der Umreifung BREAKING LOAD IN KILONEWTON loop configuration
- 5 KÖRPER UND VERSTELLBARKEIT W - weiblich, M - männlich, V - verstellbar, F - nicht verstellbar BODY PART AND ADJUSTABILITY W - female part, M - male part, V - adjustable, F - non-adjustable
- 6 TYP UND GRÖSSE F - COBRA, Y - PRO STYLE, 45 - Gurtgröße TYPE AND SIZE F - COBRA, Y - PRO STYLE, 45 - size of webbing
- 7 NAME DES HERSTELLERS NAME OF MANUFACTURER
- 8 HERSTELLUNGSLAND & CHARGENNUMMER (RÜCKSEITE) COUNTRY OF ORIGIN & BATCH NUMBER (BACK)

VORDERSEITE FRONT

# COBRA® TYPENVERGLEICH

## COBRA® COMPARISON OF TYPES



### COBRA® PRO STYLE

Die Weiterentwicklung der legendären COBRA® THE ORIGINAL - erhältlich in Aluminium und Stahl  
The evolution of the legendary COBRA® THE ORIGINAL - available in aluminium or steel



### COBRA® SNAKEBITE

Die Klemme verhindert das Kriechen des Gurtbandes.  
The clamp avoids creeping of the webbing.



### COBRA® PRO STYLE 18 KN

Hält 18 kN auf geradem Zug und entspricht der ANSI-Norm. With a breaking load tensile strength of 18 kN this buckle this buckle complies with the ANSI standard.



Bei Fragen zur Wahl der richtigen COBRA® zögere bitte nicht, uns zu kontaktieren. If you have questions about the choice of the right COBRA®, please don't hesitate to contact us.

T: +43 5225 65 248

E: office@austriapin.at



### COBRA® NAUTIC

Die COBRA® aus Edelstahl für Anwendungen auf hoher See. COBRA® made of stainless steel. For applications on the high seas.



### COBRA® FM

Kleine COBRA® für Fashion oder Freizeitanwendungen. Keine PSA! Small COBRA® for fashion or leisure activities application. No PPE!



### GT COBRA®

COBRA® aus 100 % Polymer-Kunststoff. COBRA® made of 100% polymer.



### D-RING COBRA® PRO STYLE 18 KN

Erweiterter Anwendungsbereich dank patentiertem D-Ring.  
Extended application thanks to the patented D-Ring.



### D-RING COBRA® PRO STYLE 18 KN SNAKEBITE

Erweiterter Anwendungsbereich dank patentiertem D-Ring und Klemmelement.  
Extended application thanks to the patented D-Ring and polymer clamp.



### SUPER COBRA®

Mit 23 kN Bruchkraft auf geradem Zug die stärkste COBRA®. The strongest COBRA® with 23 kN breaking load tensile strength.



### COBRA® OUL

COBRA® (mit wahlweise 9 kN oder 23 kN Bruchlast auf geradem Zug), die unter Last öffnet. Keine PSA! COBRA® that opens under load with a breaking load tensile strength of either 9 kN or 23 kN. No PPE!



### COBRA® SPECIAL DESIGNS

Verschiedene, ausgeklügelte COBRA® Komponenten für besondere Anwendungen.  
Various, sophisticated COBRA® components for special applications.



# FINDE DIE PASSENDE COBRA® CHOOSING THE RIGHT COBRA®

**ALLGEMEIN GENERAL**

- 1 CHOOSE TYPE
- 2 CHOOSE COATING AND COLOR

**HAUPTTEIL FEMALE PART**

- 3 CHOOSE ADJUSTABILITY
- 4 CHOOSE WEBBING SIZE AND WIDTH
- 5 CHOOSE CLIP SIZE AND COLOR

**SCHUBTEIL MALE PART**

- 3 CHOOSE ADJUSTABILITY
- 4 CHOOSE WEBBING SIZE AND WIDTH

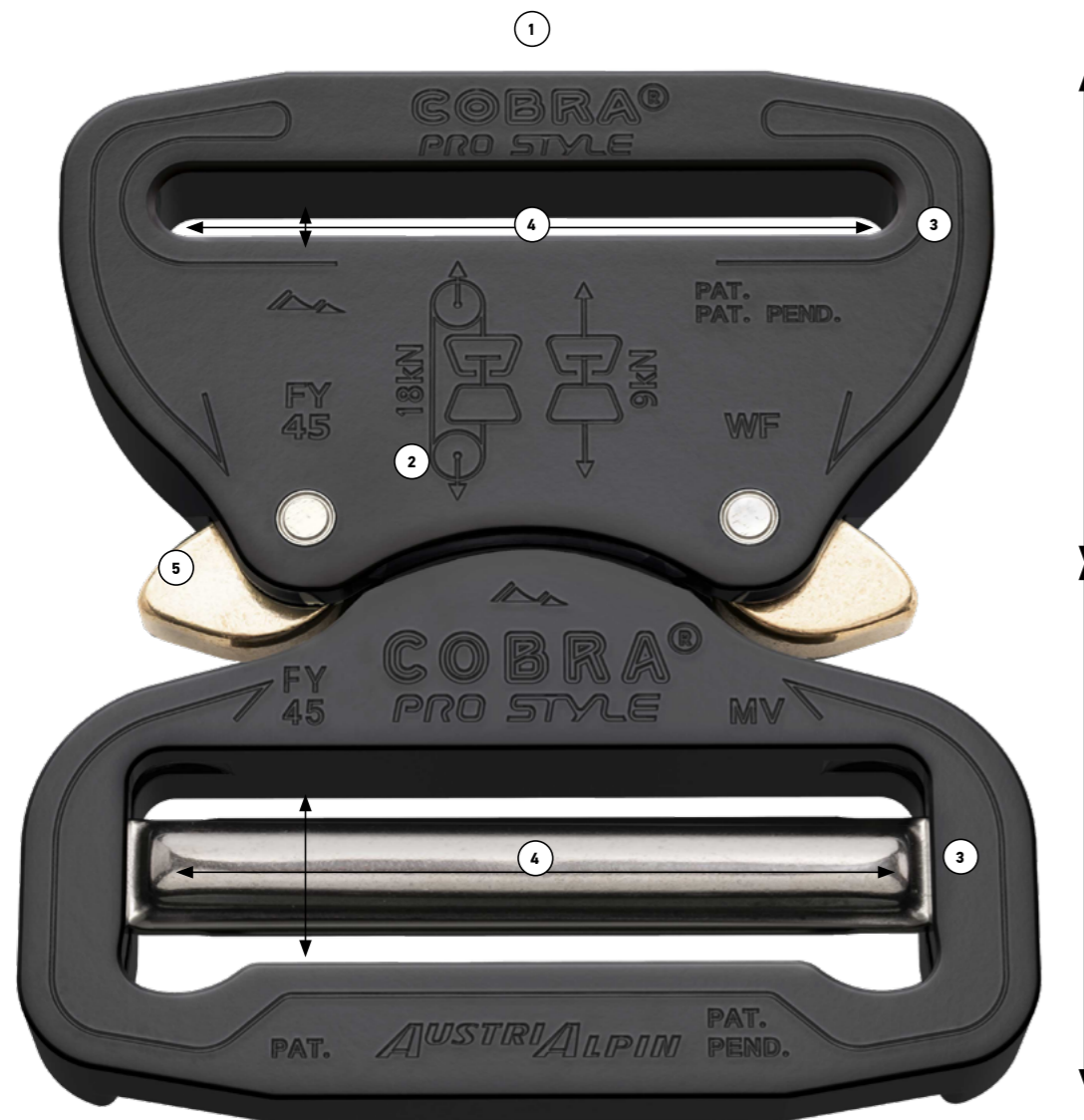

HAUPTTEIL  
FEMALE PART

SCHUBTEIL  
MALE PART

## COBRA® CODE GENERATOR FOR QUICK RELEASE BUCKLES

COBRA® BUCKLE	VERSION	WEBBING	COLOR	MALE PART	FEMALE PART	CLIP SIZE & COLOR	SPECIAL
F	Y	45	K	V	F	(-XL)	(-TE)
F	Y PRO STYLE, EN* (9 kN)	20 mm 3/4"	K black, ktl	F non-adjustable	F non-adjustable	standard brass	- TE single piece tested
	T PRO STYLE steel, EN* (9 kN)	25 mm 1"	A polished	V adjustable	V adjustable	-B standard size, black	- LS snakebite
	X PRO STYLE 18 kN, ANSI** (18 kN)	33 mm 1 1/4"	M matte black, anodized	S stretch, adjustable	S stretch, adjustable	-XS XS size, brass	- RR retrofit repair and replace
	U PRO STYLE 18 kN steel, ANSI** (18 kN)	38 mm 1 1/2"	C coyote brown	G stretch, non-adjustable	G stretch, non-adjustable	-XSB XS size, black	
	S SUPER, (23 kN)	45 mm 1 3/4"	Q brown grey	U ultra wide, non-adjustable	U ultra wide, non- adjustable	-XL XL size, brass	
	I NAUTIC stainless steel, EN* (9 kN)	50 mm 2"	G elephant grey	X extra wide, non-adjustable	X extra wide, non-adjustable	-XB XL size, black	
	M FM, non PPE (2KN)	58 mm 2 1/4"	F foliage green	N narrow, adjustable	N narrow, adjustable		
	G*** GT polymer, non PPE		S desert sand	T tri-glide, adjustable	D with integrated D-Ring, non-adjustable		
	N*** NG polymer, non PPE		T tan499		O with integrated black D-Ring, non-adjustable		
	O OUL (10 mm), non PPE		H hard coated		T tri-glide, adjustable		
	E OUL (14 mm), non PPE		and many more see page 14/15				

\* Engineered beyond EN358:2018-11 (partial)  
\*\* Engineered beyond ANSI/ASSE Z359.12-2019  
\*\*\* these buckles are only available as half parts



Alle Schnallen können auch einzelstückgeprüft werden (mit Zusatzkosten verbunden).  
We offer single piece tests of all buckles (additional costs apply).

# COBRA® PRO STYLE



## THE PRO STYLE EVOLUTION

### 1. ULTIMATIVE SICHERHEIT – VERBESSERTER VERSCHLUSS 1. REDESIGNED LOCKING MECHANISM FOR ULTIMATE SAFETY

Die Adaptationen am patentierten Schließmechanismus erlauben ein leichteres Einrasten von Haupt- und Schubteil. Dies wird akustisch durch ein deutlich hörbares Klicken bestätigt. Ein einseitiges Einrasten ist nahezu unmöglich. Im geschlossenen Zustand zeichnen sich die PRO STYLE COBRA® Schnallen durch eine sehr hohe Beweglichkeit zwischen Schubteil (male part) und Hauptteil (female part) aus. In der Maximalstellung blockiert das Schubteil den Öffnungsmechanismus mechanisch. Dadurch kann es auch in dieser Extremposition zu keiner ungewollten Öffnung kommen. The new adaption to the patented locking mechanism allows for easier engagement of the interlocking components, which can be confirmed acustically by the distinct "clicking" sound when properly closing the buckle. One-sided locking of the buckle is nearly impossible. When closed, the COBRA® PRO STYLE is characterized by the higher flexibility between the male and female parts. Under maximum traction, the male part of the buckle blocks the opening mechanism. This way, unintentional opening is prevented also in this extreme position.

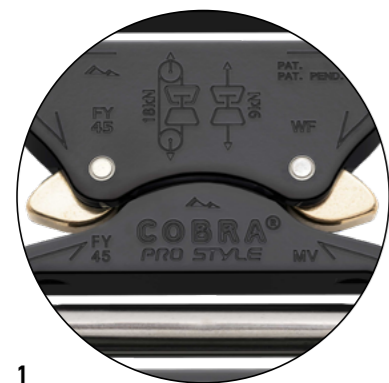

1



2

### 2. AUSFRÄSUNG AUF RÜCKSEITE 2. CUTAWAY ON BACKSIDE

Durch die größere Ausfräsung an der Rückseite der COBRA® PRO STYLE können Schmutz, Staub, Eis und Schnee leichter entweichen. Dies erhöht zusätzlich die Funktionstüchtigkeit und Langlebigkeit der Schließe. The large cut-out at the backside of the COBRA® PRO STYLE prevents dirt, dust, ice or snow from getting caught in the buckle. This increases the extreme performance capabilities and lifetime of the buckle.

Standardgrößen sind bereits jetzt Lagerware. Die COBRA® PRO STYLE wird künftig das COBRA® THE ORIGINAL Sortiment vollständig ersetzen. Standard sizes are already in stock. As an evolving development, COBRA® PRO STYLE will soon completely replace the COBRA® THE ORIGINAL line of products.



### COBRA® PRO STYLE

Alle Größen der COBRA® PRO STYLE sind untereinander kompatibel. In Verbindung mit dem passenden Gurt halten diese Schnallen garantiert 18 kN in der Umreifung. Im geschlossenen Zustand zeichnet sich die COBRA® PRO STYLE durch eine sehr hohe Beweglichkeit zwischen Schub- und Hauptteil aus. Thanks to the identical locking mechanism, all COBRA® PRO STYLE sizes are compatible. In combination with a fitting webbing, the minimum guaranteed load capacity is 18 kN in loop configuration. The COBRA® PRO STYLE is characterized itself by the high flexibility between the male and female parts while the buckle is closed.

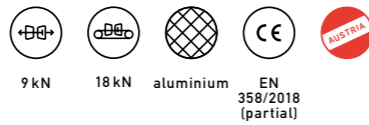

FY..*VF						
mm	A	B	C	D	E	🔒
25	14	4	40	59	10	53
33	13	4	46	60	10	61
38	12	4	50	61	10	65
45	12	4	59	64	10	74
50	13	4	63	64	10	80
58	13	4	70	65	10	87

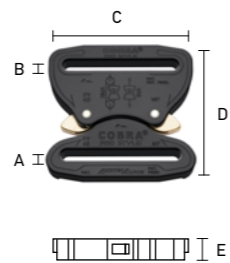

FY..*FF						
mm	A	B	C	D	E	🔒
25	4	4	39	50	10	49
33	4	4	46	52	10	54
38	4	4	50	53	10	55
45	4	4	56	54	10	61
50	4	4	62	54	10	66
58	4	4	70	56	10	72

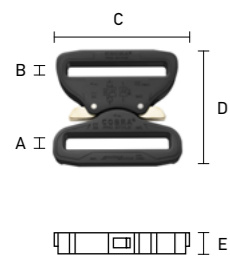

FY..*GG						
mm	A	B	C	D	E	🔒
45	8	8	56	62	10	63
58	9	9	70	67	10	77

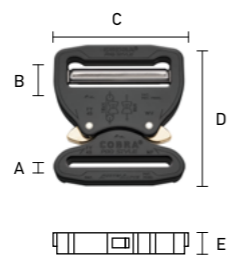

FY..*FV						
mm	A	B	C	D	E	🔒
25	4	15	40	62	10	55
38	4	13	51	63	10	68
45	4	13	58	64	10	76
50	4	13	63	64	10	83

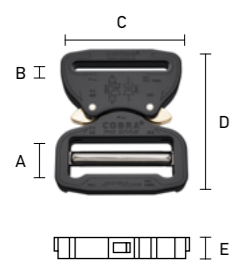

FY..*SF						
mm	A	B	C	D	E	🔒
25	17	4	40	63	10	54
38	17	4	52	67	10	68
45	17	4	58	68	10	78

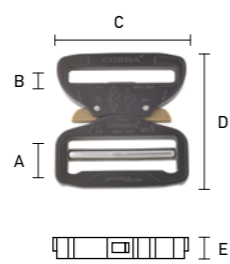

FY..*SG						
mm	A	B	C	D	E	🔒
58	19	9	70	74	10	93

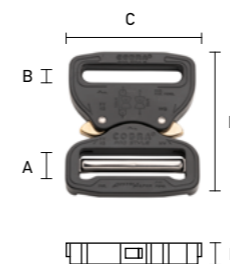

FY..*VG						
mm	A	B	C	D	E	🔒
45	12	8	59	68	10	76

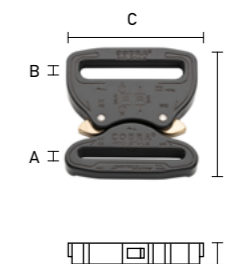

FY..*FG						
mm	A	B	C	D	E	🔒
45	4	8	56	59	10	62



FY..*VV						
mm	A	B	C	D	E	🔒
25	14	14	40	70	10	64
38	12	12	51	73	10	78
45	12	12	59	73	10	89
50	13	13	63	74	10	97

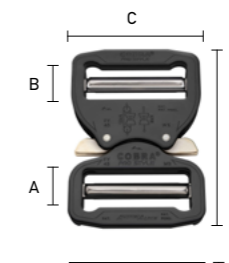

FY..*SS						
mm	A	B	C	D	E	🔒
25	17	17	39	76	10	64
45	17	17	58	82	10	90
50	17	17	63	82	10	97
58	19	19	70	88	10	107

### COBRA® PRO STYLE steel

Die COBRA® PRO STYLE aus Stahl entspricht den Anforderungen der Atemschutzgeräte-Norm EN 137. Für den bestmöglichen Schutz wird die COBRA® Schnalle doppelt beschichtet: erst verzinkt und anschließend ktl-beschichtet. Alle Größen und Varianten der COBRA® PRO STYLE aus Stahl (FT) sind untereinander kompatibel. Die Stahlversion darf nicht mit Teilen der COBRA® PRO STYLE aus Aluminium kombiniert werden. The COBRA® PRO STYLE made of steel meets the requirements of the norm for respiratory protective equipment EN 137. For the best possible protection, the COBRA® buckle is coated twice: first zinc-coated and then ktl-coated. All sizes and variants of the COBRA® PRO STYLE steel version (FT) are compatible with each other. The steel version must not be combined with parts of the COBRA® PRO STYLE made of aluminium.

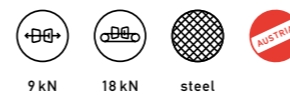

FT..*VG						
mm	A	B	C	D	E	🔒
45	12	8	58	68	10	162

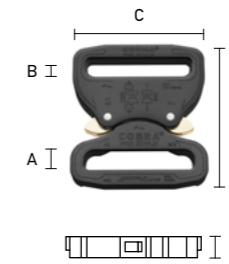

FT..*GG						
mm	A	B	C	D	E	🔒
45	8	8	56	61	10	146

# COBRA® PRO STYLE SNAKEBITE



## COBRA® PRO STYLE SNAKEBITE

Die neue COBRA® PRO STYLE SNAKEBITE ist eine Sicherheitsschnalle, die auf dem patentierten Verschlusssystem der COBRA® PRO STYLE basiert. Sie besteht aus Aluminium und ist mit einem zusätzlichen Klemmelement aus Polymerkunststoff ausgestattet, welches das längenverstellbare Gurtband an der gewünschten Position fixiert und ein mögliches "Kriechen" des Gurtbandes verhindert. The new COBRA® PRO STYLE SNAKEBITE safety buckle is made of premium aluminum alloy and features our proven COBRA® PRO STYLE locking mechanism. It comes with an additional clamp made of polymer that locks the adjustable belt strap in the desired position and prevents possible "creeping" of the webbing.

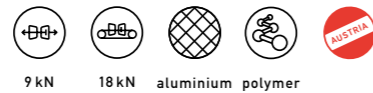

9 kN 18 kN aluminium polymer AUSTRIA

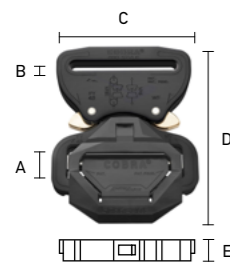

FY..\*VF-LS

mm	A	B	C	D	E	Ⓜ
25	14	4	39	72	10	60
33	13	4	45	73	10	69
38	13	4	50	73	10	72
45	13	4	56	74	10	77
50	13	4	62	74	10	83



# COBRA® PRO STYLE 18 KN



## COBRA® PRO STYLE 18 KN

Die COBRA® PRO STYLE 18 kN ist etwas dicker und dadurch noch stärker als die COBRA® PRO STYLE und entspricht dem ANSI Z359.12-2019 Standard mit einer Mindestbruchkraft von 15 kN. Wir garantieren jedoch 18 kN und weisen dies in den technischen Daten entsprechend aus. The COBRA® PRO STYLE 18 kN is thicker and even stronger than the COBRA® PRO STYLE and complies with the ANSI Z359.12-2019 standard with a minimum tensile strength of 15 kN. However, we guarantee 18 kN and point this out in the technical specifications accordingly.

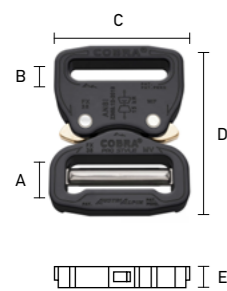
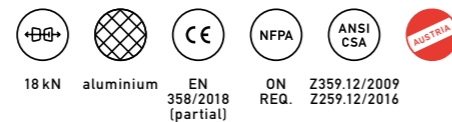

FX..*VF							
mm	A	B	C	D	E	Ⓜ	
25	14	8	40	63	12	68	
38	12	8	52	64	12	82	
45	12	8	58	66	12	91	



FX..*FF							
mm	A	B	C	D	E	Ⓜ	
25	8	8	40	59	12	68	
45	8	8	58	60	12	76	

# D-RING COBRA® PRO STYLE 18 KN

## D-RING COBRA® PRO STYLE 18 KN

Für diese innovative Komponente wurden zwei AUSTRIALPIN Produkte im Bereich Safety-Hardware gekreuzt: der D-Ring und die COBRA® PRO STYLE 18 kN. Die einzigartige Konstruktionsweise erlaubt eine zentrale Positionierung des D-Rings und verhindert, dass der D-Ring unter Zug gegen das Gurtband drückt und somit blockiert. Die D-RING COBRA® PRO STYLE 18 kN entspricht dem ANSI Z359.12-2019 Standard mit einer Mindestbruchkraft von 15 kN. Wir garantieren jedoch 18 kN und weisen dies in den technischen Daten entsprechend aus. This innovative component is a synergistic hybrid of two standard components of safety industry hardware: the stainless-steel d-ring and the COBRA® PRO STYLE 18 kN – Its unique construction prevents the D-ring from getting squeezed against the webbing and therefore guarantees easy handling. The D-RING COBRA® PRO STYLE 18 kN complies with the ANSI Z359.12-2019 standard with a minimum tensile strength of 15 kN for the buckle and 22 kN for the d-ring. However, we guarantee 18 kN for the buckle (straight pull) and point this out in the technical specifications accordingly.

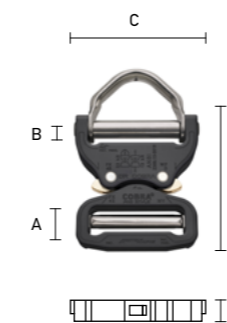

FX..*VD							
mm	A	B	C	D	E	Ⓜ	
25	14	9	48	67	14	122	
38	12	5	58	69	14	139	
45	12	5	64	67	14	151	
50	12	5	68	71	14	163	

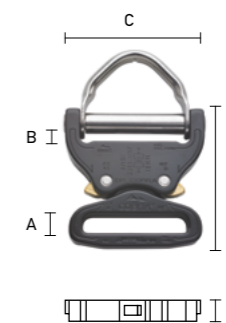

FX..*FD							
mm	A	B	C	D	E	Ⓜ	
45	8	5	64	62	14	136	
50	8	5	68	66	14	150	

# D-RING COBRA® PRO STYLE 18 KN SNAKEBITE



## D-RING COBRA® PRO STYLE 18 KN SNAKEBITE

Die D-RING COBRA® PRO STYLE 18 KN SNAKEBITE ist eine innovative Kombination dreier AUSTRIALPIN-Komponenten. Sie verbindet die herausragenden Eigenschaften der COBRA® PRO STYLE 18 kN, mit einem direkt in den Hauptteil integrierten Edelstahl D-Ring. Das zusätzlich am Schubteil angebrachte SNAKEBITE Klemmelement aus robustem Polymer fixiert das längenverstellbare Gurtband an der gewünschten Position und verhindert ein unerwünschtes "Kriechen" des Gurtbandes. Die D-RING COBRA® PRO STYLE 18 kN entspricht dem ANSI Z359.12-2019 Standard mit einer Mindestbruchkraft von 15 kN. Wir garantieren jedoch 18 kN und weisen dies in den technischen Daten entsprechend aus. The D-RING COBRA® PRO STYLE 18 kN SNAKEBITE is a powerful fusion of three classical AUSTRIALPIN components: the COBRA® PRO STYLE 18 kN Aluminium buckle and the stainless-steel D-RING. The additionally attached innovative SNAKEBITE polymer clamp locks the adjustable belt strap in place and prevents webbing creep, even when you're on the move. The D-RING COBRA® PRO STYLE 18 kN complies with the ANSI Z359.12-2019 standard with a minimum tensile strength of 15 kN for the buckle and 22 kN for the d-ring. However, we guarantee 18 kN for the buckle (straight pull) and point this out in the technical specifications accordingly.

NEW

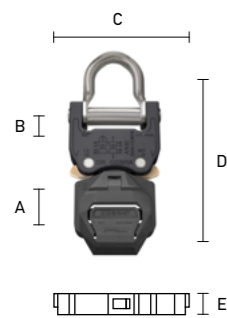
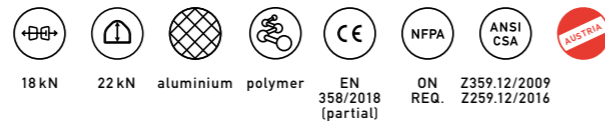

FX..\*VD-LS

mm	A	B	C	D	E	
25	14	5	48	111	19	120



# BILD d-ring Snakebite

# COBRA® PRO STYLE RETROFIT 18 KN



## COBRA® PRO STYLE RETROFIT 18 KN

Ursprünglich hergestellt für die US Navy besteht die COBRA® PRO STYLE 18 kN RETROFIT aus einer COBRA® PRO STYLE 18 kN mit verstellbarem Steg am Schutteil und austauschbarer Achse am Hauptteil. Mit ihr können alte oder minderwertige Schnallen in Systemen mit fix vernähten Gurtbändern, wie sie oft bei Gurtzeug oder Gürteln zu finden sind, ausgetauscht werden, ohne das vernähte Gurtband zu zerstören. Sie ist vielseitig einsetzbar - wo immer eine Schnalle öfter ausgetauscht oder versetzt werden muss. Die COBRA® PRO STYLE 18 kN RETROFIT entspricht dem ANSI Z359.12-2019 Standard mit einer Mindestbruchkraft von 15 kN. Wir garantieren jedoch 18 kN und weisen dies in den technischen Daten entsprechend aus. Made for the US Navy, the COBRA® PRO STYLE 18 kN RETROFIT was designed to replace existing inferior or worn hardware in any sewn webbing or fixed system (e.g.: harnesses). Perfect for applications where fragile parts (plastic) need to be replaced with a high quality product without destroying the sewn webbing product (e.g.: belts). It also functions as a versatile 'removable - movable' safety buckle. The COBRA® PRO STYLE 18 kN RETROFIT complies with the ANSI Z359.12-2019 standard with a minimum tensile strength of 15 kN. However, we guarantee 18 kN and point this out in the technical specifications accordingly.

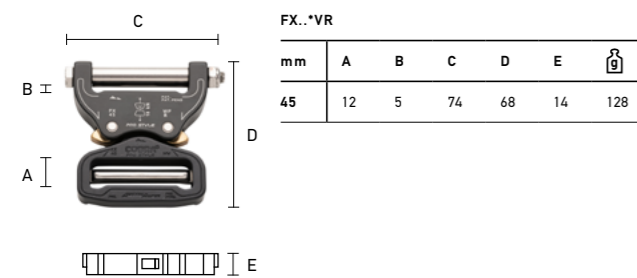

# SUPER COBRA®

## SUPER COBRA®

Unsere stabilste und stärkste COBRA®-Schnalle wurde für die Sicherung von schwerer Ladung entwickelt. Der patentierte Verstellsteg sorgt dabei für Stabilisation und Schonung des Gurtbandes. In Verbindung mit dem passenden Gurtband hält die SUPER COBRA® garantiert 46 kN in der Umreifung. Our strongest COBRA® buckle was designed to secure heavy vehicle load safely. The patented locking bolt on the adjustable part stabilizes the webbing and prevents it from damage. The SUPER COBRA® guarantees 46 kN breaking strength in loop configuration.

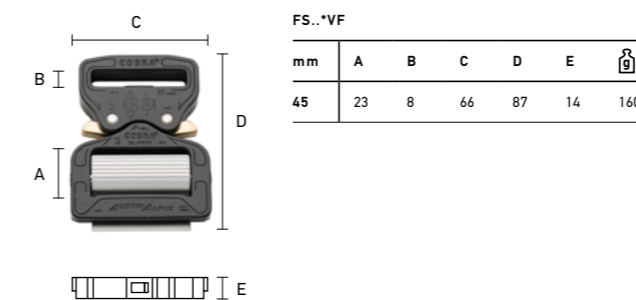

# COBRA® NAUTIC



## COBRA® NAUTIC

Die COBRA® NAUTIC ist extrem seewasserfest, da sie ausschliesslich aus hochseetauglichem Edelstahl gefertigt wird, der auch im Schiffsbau verwendet wird. Made of stainless steel and designed for ultimate safety performance in the most severe oxidizing environments. Ideal for applications like offshore rigging, navy, coast guard, scuba, marine hardware, bosun supplies, yachting and wherever nature demands the ultimate in performance.

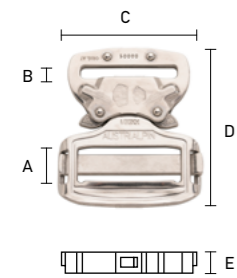
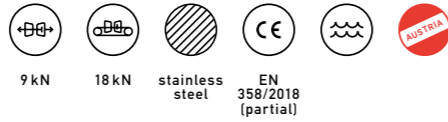

FI..VF						
mm	A	B	C	D	E	🔒
45	16	5	65	76	8	



FC41VA4-F polymer anti sliding bridge						
mm	A	B	C	D	E	🔒
45	-	-	70	21	11	7
>> BUCKLE IS NOT INCLUDED <<						



photocredit: AUSTRIALPIN GmbH



# COBRA® FM

## COBRA® FM

Die COBRA® FM basiert auf dem patentierten COBRA® Quick Release Verschlusssystem. Designed als stabiles und zuverlässiges Leichtgewicht ist die sie besonders gut als technisches Stilelement auf Taschen und Gürteln geeignet. Funktionalität und Gewicht machen sie aber auch für den sportlichen Einsatz zum perfekten Kandidaten. Die COBRA® FM ist nicht PSA tauglich. The COBRA® FM is based on our patented COBRA® Quick Release technology for a secure closure. As a very strong and reliable non-PSA buckle, it is designed for apparel (e.g. belts), general use in the sports industry (e.g. backpacks, PFDs) or anywhere a sweet, high-quality buckle is needed.



aluminium

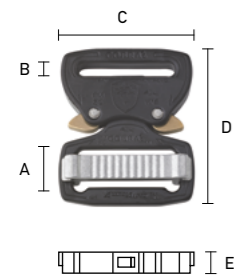

FM..*VF							
mm	A	B	C	D	E	🔒	
20	11	4	33	44	9	18	
25	11	4	38	47	9	19	

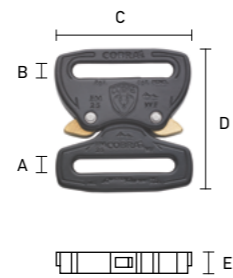

FM..*FF							
mm	A	B	C	D	E	🔒	
20	4	4	33	39	7	15	
25	4	4	38	40	7	16	

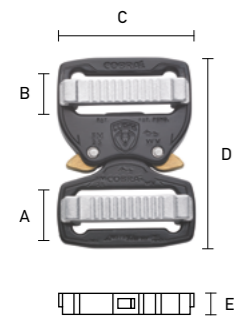

FM..*VV							
mm	A	B	C	D	E	🔒	
20	11	11	33	53	9	19	
25	11	11	38	54	9	21	

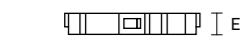

## COBRA® FM Retrofit Repair and Replace (RnR)

Die neue COBRA® FM Retrofit RnR basiert auf dem patentierten COBRA® Quick Release Verschlusssystem und wurde mit einer brandneuen Repair and Replace (RnR) Funktion erweitert. Der clevere Schlitz am Hauptteil ermöglicht das einfache Austauschen einer abgenutzten oder gebrochenen Schnalle in einer Gurtbandschleife. Genauso, wie man es braucht. Schnell, einfach und unkompliziert. Die COBRA® FM Retrofit RnR eignet sich perfekt zum Nachrüsten an Rucksäcken, Taschen, Gürteln und Befestigungsriemen. Sie ist leicht, kompakt, stabil und zuverlässig. Die Bruchfestigkeit der Schnalle wird durch die zusätzliche Funktion nicht beeinträchtigt. Aufgrund der Leichtbauweise darf die Schnalle nicht an lasttragenden Stellen angebracht werden (keine PSA-Komponente).

The COBRA® FM Retrofit RnR is based on our patented COBRA® Quick Release technology for a secure lock. It is equipped with a brand-new Repair and Replace (RnR) feature. The clever slot on the main part makes it easy to replace a worn-out or broken buckle in your webbing loop. Quick, easy, and hassle-free. The COBRA® FM Retrofit RnR is a perfect technical element for retrofitting your backpacks, bags, belts, tents, and all sorts of fastening straps. It is light, compact, stable and reliable. The new RnR function does not affect the breaking strength of the buckle. Due to its lightweight design, the buckle is not intended for load-bearing applications (no PPE).



aluminium

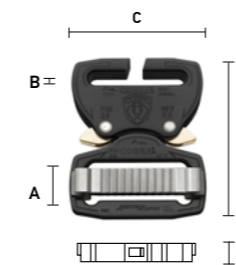

FM**KVF-RR							
mm	A	B	C	D	E	🔒	
20	11	4	32	46	7	18	
25	11	4	38	47	9	19	

On request available in various coating options.



## HOW TO REPAIR AND REPLACE



REMOVE DAMAGED BUCKLE



INSERT THE WEBBING LOOP INTO THE SLOT AT THE FEMALE PART



USE THE ADJUSTER BAR ON THE MALE PART OF THE BUCKLE TO THREAD IT INTO THE WEBBING



AND YOU ARE READY TO GO!

# GT COBRA®



## GT COBRA®

Aus der Zusammenarbeit mit ITW Nexus™ ist die erste COBRA® Schnalle aus 100% Polymer-Kunststoff ohne Metallkomponenten entstanden. Robuster als jede bestehende Kunststoff Hardware, überzeugt die GT COBRA® mit ihrem Leichtgewicht und der Geräuscharmheit beim Klippen. Dank GhillieTEX™ Technologie ist sie zudem infrarotneutral und erfüllt zu 100% das U.S. Berry Amendment for Government applications. Die GT COBRA® ist nicht PSA tauglich. Designed to be more robust than any other type of polymer hardware with a target load of 500 lbs, the GT COBRA® buckle is a 100% polymer system with no metal springs or hinges. A few of the many GT COBRA® advantages are its lightweight and low-noise construction, infrared reduction compliance and 100% U.S. Berry Amendment compliance. Not suitable as PPE!



polymer

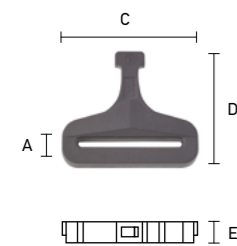

FG..*MF							
mm	A	B	C	D	E	🔒	
38	4	-	54	50	12	13	
45	4	-	61	53	12	15	
50	4	-	67	53	12	16	

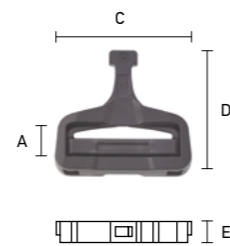

FG..*MV							
mm	A	B	C	D	E	🔒	
38	15	-	56	60	14	19	
45	15	-	63	60	14	21	
50	15	-	70	62	14	22	

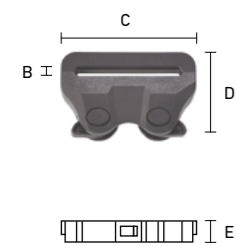

FG..*WF							
mm	A	B	C	D	E	🔒	
38	-	4	54	40	14	21	
45	-	4	61	40	14	24	
50	-	4	67	40	14	25	

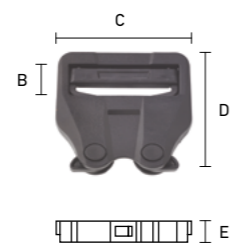

FG..*WV							
mm	A	B	C	D	E	🔒	
38	-	15	58	59	14	35	
45	-	15	65	59	14	39	
50	-	15	71	59	14	40	



# COBRA® OPEN UNDER LOAD (OUL)

## OUL TECHNOLOGY AND PRODUCT RANGE

Eine COBRA® OUL lässt sich im Gegensatz zu allen anderen COBRA® Schnallen auch unter Zug öffnen. Damit eignet sie sich bestens für Anwendungen zur Ladungssicherung oder zur Befestigung von Gegenständen, die immer sofort griffbereit sein müssen. Sie darf jedoch keinesfalls als persönliche Schutzausrüstung zum Einsatz kommen. Bei den Bruchlastwerten steht sie ihren nicht-OUL Modellen aber in Nichts nach. OUL-Modelle sind mit klassischen COBRA® Quick Release Schnallen nicht kompatibel. OUL-Modelle des gleichen Typs können jedoch miteinander kombiniert werden. Unlike all other COBRA® Quick Release buckles, all COBRA® OUL can be opened under load. Therefore it can for example be used to secure cargo or wherever items have to be immediately accessible. This is why it can't be used as a personal protective equipment. However, the breaking load is still the same as the one of the non-OUL models. A COBRA® OUL can not be combined with a regular COBRA®, but a COBRA® OUL can be combined any other COBRA® OUL of the same type.

Auf Anfrage stellen wir unsere COBRA® Modelle auch als OUL-Version her. Hier sind einige Beispiele: On request we will produce COBRA® Quick Release buckles with OUL-technology. Here are some examples:

**1. „No PPE“ marking**  
Diese COBRA® ist nicht Teil einer persönlichen Schutzausrüstung. This COBRA® is not part of PPE.

**2. „OUL“ Marking**  
Diese COBRA® lässt sich auch unter Last öffnen. This COBRA® opens under load.

## COBRA® OUL 9 KN

Die COBRA® OUL (9 kN) lässt sich unter Last öffnen. In Verbindung mit dem passenden Gurt hält die Schnalle garantiert 9 kN auf geradem Zug und 18 kN in der Umreifung. Diese Schnalle ist nicht PSA-tauglich. The COBRA® OUL (9 kN) can be opened under load. In combination with a fitting webbing, the minimum guaranteed load capacity is 18 kN in loop configuration. Not suitable as PPE!



		FO..*VF					
		mm	A	B	C	D	E
	25	12	6	40	58	10	52
	38	12	4	52	61	10	67
	45	12	4	58	60	10	73
	50	12	4	63	62	10	82

		FO..*FF					
		mm	A	B	C	D	E
	25	4	4	40	52	10	48

## COBRA® OUL 23 KN

Die „Open Under Load“-Variante unserer stabilsten und stärksten Schnalle wurde für die Sicherung von schwerer Ladung, beispielsweise in minenwiderstehenden Fahrzeugen, entwickelt. Der patentierte Verstellsteg sorgt für Stabilisation und Schonung des Gurtbandes. Die SUPER COBRA® ist nicht PSA-tauglich. The "open under load" version of our strongest buckle was specifically designed for JPO MRAP in conjunction with Picatinny Arsenal and TACOM for the application in MRAP vehicle load securing initiatives. The patented locking bolt on the adjustable part stabilizes the webbing and prevents it from damage. The SUPER COBRA® OUL loads up to 46 kN in loop configuration. Not suitable as PPE!

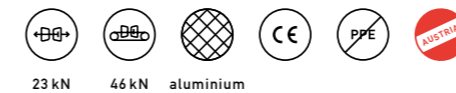

		FE..*VF					
		mm	A	B	C	D	E
	45	23	7	64	86	14	161

# COBRA® SPECIAL DESIGNS



FY90KVF-T25K+L

## COBRA® Special Designs

Verschiedene Mittelplatten, kompatibel mit COBRA® THE ORIGINAL oder COBRA® FM. T-piece, triple or quadruple middle plate, compatible with COBRA® THE ORIGINAL or COBRA® FM only.



aluminium



FY90KVV-T25K+L

FY90KFF-T25A+L

FY56\*... FY90\*...

mm	non-adjustable   non-adjustable	adjustble   non-adjustable	adjustable   adjustable
25	FY56*FF-T25*+L	FY56*VF-T25*+L	FY56*VV-T25*+L
45	FY90*FF-T25*+L	FY90*VF-T25*+L	FY90*VV-T25*+L

Weitere Beispiele für Mittelplatten:  
More samples of middle plates:



FC18\*

triple plate for COBRA® THE ORIGINAL  
No PPE!



FC00QUA

quake plate for COBRA® THE ORIGINAL



FC00\*-VEST

vest plate for COBRA® THE ORIGINAL



FM00\*CC-WE

vest connector with COBRA® FM  
No PPE!

## COBRA® ANCHOR OUL

Ursprünglich diente die COBRA® ANCHOR OUL als Befestigungssystem an MRAP-Fahrzeugen des Picatinny Arsenal der US Army. Sie besteht aus einer Platte, an der das Hauptteil einer COBRA® OUL befestigt ist, welches sich um 180° in der horizontalen Achse verstellen lässt. So können Gegenstände und Ausrüstung, die mit einem COBRA® OUL (9 kN) Schubteil ausgestattet sind, einfach, schnell und sicher verstaut werden. Die COBRA® ANCHOR ist perfekt für Ladungssicherungssysteme in Fahr- oder Flugzeugen oder überall dort, wo „clip and go“-Befestigungssysteme notwendig sind. Sie ist jedoch nicht PSA-tauglich. Originally designed for Picatinny Arsenal as a conceptual MRAP anchoring system, the COBRA® ANCHOR OUL bolts (1/2 inch hardware) onto any solid surface. The female buckle portion of the anchor can be tilted by up 180 degrees offering a wide angle of use and variability. A COBRA® OUL (9 kN) male part is then affixed to any gear, kit, or package whereby it can be securely clipped in and stowed away for rapid, easy, safe access. This is great for vehicular and aircraft stowage applications as well as for applications where load bearing "clip and go" storage options are required. Not suitable as PPE!

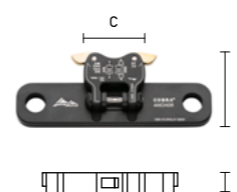
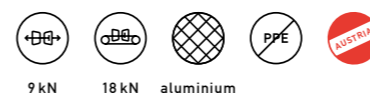

F000*180-XL						
mm	A	B	C	D	E	Ⓜ
25	-	-	40	37	10	104



# RÜCKFÄDELSCHNALLEN UND RINGE THREAD BACK BUCKLES AND RINGS



## COBRAFRAME 18 KN EASY RELEASE

Easy-Release-Funktion für extra schnelles Öffnen mit dem Daumen.  
Revolutionary buckle with extra fast thumb tab release.

Nach ANSI-Norm zertifiziert.  
Certified according to the ANSI standard.

Hält garantiert 36 kN in der Umreifung.  
Guaranteed 36 kN breaking load in loop configuration.



# RÜCKFÄDELSCHNALLEN UND RINGE TYPENVERGLEICH THREAD BACK BUCKLES AND RINGS COMPARISON OF TYPES



COBRAFRAME



COBRAFRAME SNAKEBITE

NEW



COBRAFRAME 18 KN



COBRAFRAME 18 KN FIX



D-RING  
COBRAFRAME 18 KN



D-RING  
COBRAFRAME 18 KN  
EASY RELEASE



COBRAFRAME 18 KN  
EASY RELEASE



Bei Fragen zur Auswahl der richtigen Komponente zögere bitte nicht, uns zu kontaktieren. If you have questions about the choice of the right component, please don't hesitate to contact us.

T: +43 5225 65 248

E: office@austrialspin.at



RING 22 KN  
D-SHAPE



RING 22 KN  
DOUBLE D-SHAPE



RING 22 KN  
O-SHAPE



SLIDEBLOC



BELT BUCKLE



BELT BUCKLE  
STAINLESS STEEL

# COBRAFRAME

## COBRAFRAME



### COBRAFRAME

Aluminiumschnalle mit beweglichem Mittelsteg aus Edelstahl. In Standard-, Light- und Stretchversion erhältlich. Aluminium buckle with stainless steel adjuster bar. Available as standard, light and stretch version.

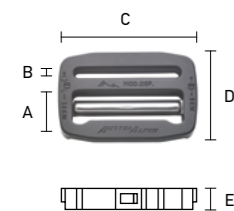
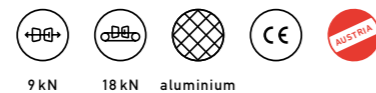

FC..CF-*						
mm	A	B	C	D	E	🔒
25	14	4	40	35	10	23
33	12	4	47	34	10	29
38	12	4	51	38	10	36
45	12	4	58	38	10	48

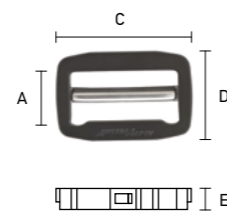

FC..LCF-*						
mm	A	B	C	D	E	🔒
45	21	-	58	38	10	36

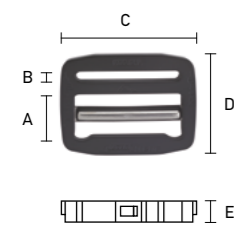

FC..SCF-*						
mm	A	B	C	D	E	🔒
25	17	4	39	38	10	25
33	16	4	47	38	10	30
38	18	4	51	43	10	41
45	18	4	58	43	10	43
50	17	4	64	42	10	47

### COBRAFRAME SNAKEBITE

Die COBRAFRAME SNAKEBITE ist eine Rückfädelschnalle aus Aluminium mit beweglichem Mittelsteg aus Edelstahl. Sie verfügt über ein zusätzliches Klemmelement, der SNAKEBITE, welches das längenverstellbare Gurtband an der gewünschten Position fixiert und ein "Kriechen" des Gurtbandes verhindert. Die Gurtbandklemme ist mit einem Klemmechanismus und Fangzähnen ausgestattet. Wird sie zugeklappt, fixiert sie das Gurtband, sodass es sich selbst unter Bewegung nicht lockert. Die SNAKEBITE Gurtbandklemme besteht aus hochfestem Polymer Kunststoff und wird im Spritzgussverfahren hergestellt. Dank ihrer Konstruktionsweise ist sie besonders robust und widerstandsfähig. The COBRAFRAME SNAKEBITE is a aluminium thread-back buckle with a movable adjuster bar made of stainless steel. It comes with an additional clamp, called SNAKEBITE, that locks the adjustable belt strap in the desired position and prevents possible "creeping" of the webbing. Belt straps can be easily adjusted, but once they have been set to the right length, they may still loosen a bit during regular loading and unloading. Our SNAKEBITE has a clamp with teeth that lock the webbing. This prevents the strap from loosening, even when you're on the move. Once the buckle and clamp are engaged, you can still pull the strap tighter, making the belt system comfortable and safe.



NEW

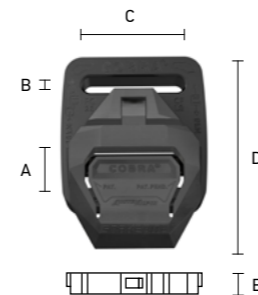

#### FC25CF-K-LS

mm	A	B	C	D	E	🔒
25	14	4	28	50	16	35

On request available in various coating options.

### COBRAFRAME 18 KN

Die COBRAFRAME 18 kN Rückfädelschnalle aus Aluminium mit beweglichem Mittelsteg aus Edelstahl in der Standardversion entspricht dem ANSI Z359.12-2019 Standard und überzeugt mit 15 kN Bruchkraft auf geraden Zug. In Verbindung mit dem passenden Gurt garantieren wir jedoch 18 kN und weisen dies in den technischen Daten entsprechend aus. The COBRAFRAME 18 kN thread back buckle made of aluminium with stainless-steel adjuster bar in the standard version complies with the ANSI Z359.12-2019 standard and convinces with a guaranteed tensile strength of 15 kN. However, in combination with the right webbing, we guarantee 18 kN and point this out in the technical specifications accordingly.

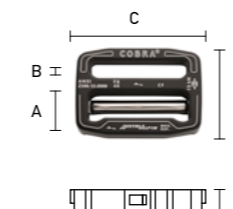
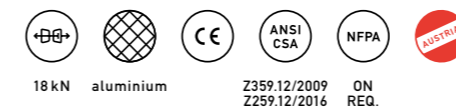

FA..CF-*						
mm	A	B	C	D	E	🔒
25	14	8	39	39	12	72
38	12	8	51	41	12	85
45	12	8	58	41	12	50

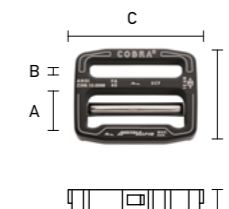

FA..SCF-*						
mm	A	B	C	D	E	🔒
25	16	8	51	38	12	41
38	16	8	51	45	12	46
45	16	8	58	45	12	52



## COBRAFRAME 18 KN FIX

Die COBRAFRAME 18 kN Rückfädelschnalle aus Aluminium mit hochwertig gefräster Oberfläche und abgerundeten Kanten entspricht dem ANSI Z359.12-2019 Standard und überzeugt mit 15 kN Bruchkraft auf geraden Zug. In Verbindung mit dem passenden Gurt garantieren wir jedoch 18 kN und weisen dies in den technischen Daten entsprechend aus. The COBRAFRAME 18 kN thread back buckle made of aluminium with a milled premium surface and rounded edges complies with the ANSI Z359.12-2019 standard and convinces with a guaranteed tensile strength of 15 kN. However, we guarantee 18 kN and point this out in the technical specifications accordingly.

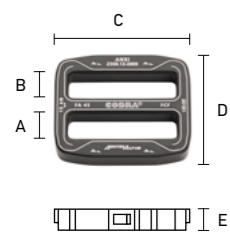
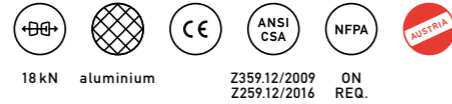

FA45FCF-*						
mm	A	B	C	D	E	🔒
45	11	11	58	47	12	53

## D-RING COBRA FRAME 18 KN

Die COBRAFRAME 18 kN Rückfädelschnalle aus Aluminium mit beweglichem Mittelsteg aus Edelstahl und D-Ring aus Edelstahl entspricht dem ANSI Z359.12-2019 Standard und überzeugt mit 15 kN Bruchkraft auf geraden Zug. In Verbindung mit dem passenden Gurt garantieren wir jedoch 18 kN für die Schnalle und 22 kN für den D-Ring und weisen dies in den technischen Daten entsprechend aus. The COBRAFRAME 18 kN thread back buckle made of aluminium with stainless-steel adjuster bar and stainless-steel d-ring complies with the ANSI Z359.12-2019 standard and convinces with a guaranteed tensile strength of 15 kN. However, we guarantee 18 kN for the buckle and 22 kN for the d-ring and point this out in the technical specifications accordingly.

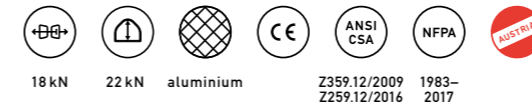

FA..CF-*D						
mm	A	B	C	D	E	🔒
25	-	16	48	34	14	72
38	-	16	58	34	14	85
45	-	16	64	34	14	94

## D-RING COBRAFRAME 18 KN EASY RELEASE

Die COBRAFRAME 18 kN Rückfädelschnalle aus Aluminium mit beweglichem Mittelsteg aus Edelstahl, D-Ring und Easy-Release-Funktion für extra schnelles Lösen mit dem Daumen entspricht dem ANSI Z359.12-2019 Standard und überzeugt mit 15 kN Bruchkraft auf geraden Zug. In Verbindung mit dem passenden Gurt garantieren wir jedoch 18 kN für die Schnalle und 22 kN für den D-Ring und weisen dies in den technischen Daten entsprechend aus. Stretch-Version für die Anwendung mit dicken Gurtbändern. The COBRAFRAME 18 kN thread back buckle made of aluminium with stainless-steel adjuster bar, D-ring and Easy Release Function for extra fast thumb tab release complies with the ANSI Z359.12-2019 standard and convinces with a guaranteed tensile strength of 15 kN. However, we guarantee 18 kN for the buckle and 22 kN for the d-ring and point this out in the technical specifications accordingly. Stretch version for perfect function with thicker webbings.

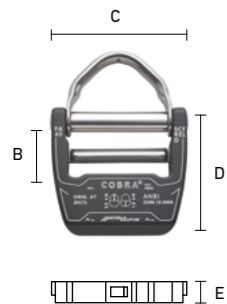
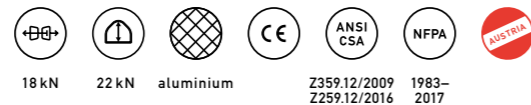

FA..SCF-*D-REL						
mm	A	B	C	D	E	🔒
25	-	21	48	59	14	87
38	-	21	58	59	14	101
45	-	21	64	59	14	109

## COBRAFRAME 18 KN EASY RELEASE

Die COBRAFRAME 18 kN Rückfädelschnalle aus Aluminium mit beweglichem Mittelsteg aus Edelstahl und Easy-Release-Funktion für extra schnelles Lösen mit dem Daumen entspricht dem ANSI Z359.12-2019 Standard und überzeugt mit 15 kN Bruchkraft auf geraden Zug. In Verbindung mit dem passenden Gurt garantieren wir jedoch 18 kN und weisen dies in den technischen Daten entsprechend aus. The COBRAFRAME 18 kN thread back buckle made of aluminium with stainless-steel adjuster bar and Easy Release Function for extra fast thumb tab release complies with the ANSI Z359.12-2019 standard and convinces with a guaranteed tensile strength of 15 kN. However, we guarantee 18 kN and point this out in the technical specifications accordingly.

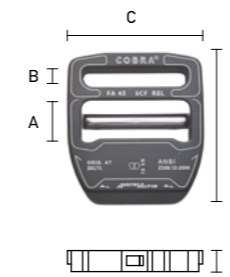
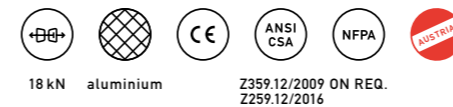

FA..SCF-*REL						
mm	A	B	C	D	E	🔒
45	16	8	58	65	12	65

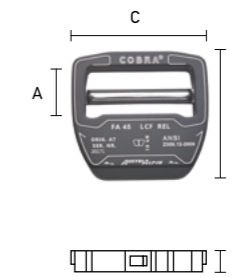

FA..LCF-*REL						
mm	A	B	C	D	E	🔒
45	20	-	58	54	12	52



# RINGE RINGS



## RING D-shape

D-Ring für unterschiedlichste Anwendungsmöglichkeiten. In gewohnter AUSTRIALPIN Qualität mit premium Oberfläche und gefasteten Kanten. Alle Ringe werden einzelstückgeprüft. Single D-ring for many different applications. Premium surface and rounded edges. All rings are single piece tested.

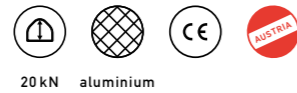

20 kN aluminium

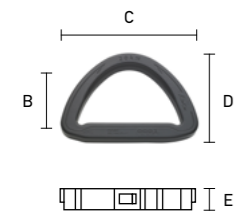

DR..10*							
mm	A	B	C	D	E	R	
25	-	15	42	29	10	16	
45	-	26	62	41	10	28	

## D-RING 22 KN

Der D-RING 22 kN entspricht dem ANSI Z359.12-2019 Standard mit einer garantierten Zugkraft von 22 kN und bietet unterschiedlichste Anwendungsmöglichkeiten. Er überzeugt mit bester AUSTRIALPIN Qualität und einer hochwertigen, gefrästen Oberfläche sowie abgerundeten Kanten. Alle Ringe werden einzelstückgeprüft. The D-RING 22 kN complies with the ANSI Z359.12-2019 standard with a guaranteed tensile strength of 22 kN and offers many different application possibilities. It convinces with best AUSTRIALPIN quality and a milled premium surface as well as rounded edges. All rings are single piece tested.

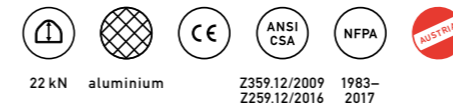

22 kN aluminium Z359.12/2009 Z259.12/2016 1983-2017

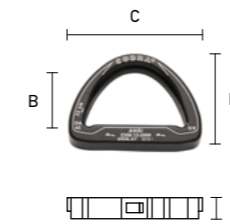

DA..DR-*							
mm	A	B	C	D	E	R	
25	-	15	42	29	12	21	
45	-	26	62	41	12	36	



## DOUBLE-D-RING 22 KN

Der DOUBLE-D-RING 22 kN entspricht dem ANSI Z359.12-2019 Standard mit einer garantierten Zugkraft von 22 kN und bietet unterschiedlichste Anwendungsmöglichkeiten. Er überzeugt mit bester AUSTRIALPIN Qualität und einer hochwertigen, gefrästen Oberfläche sowie abgerundeten Kanten. Alle Ringe werden einzelstückgeprüft. The DOUBLE-D-RING 22 kN complies with the ANSI Z359.12-2019 standard with a guaranteed tensile strength of 22 kN and offers many different application possibilities. It convinces with best AUSTRIALPIN quality and a milled premium surface as well as rounded edges. All rings are single piece tested.

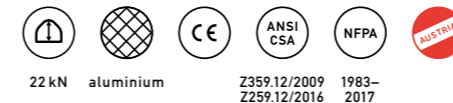

22 kN aluminium Z359.12/2009 Z259.12/2016 1983-2017

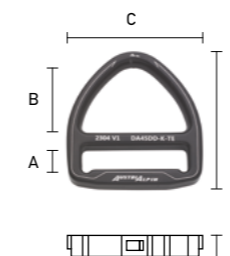

DA..DD-*							
mm	A	B	C	D	E	R	
45	10	28	59	61	12	52	





## RING O-shape

O-Ring für unterschiedlichste Anwendungsmöglichkeiten. In gewohnter AUSTRIALPIN Qualität mit premium Oberfläche und gerundeten Kanten. Single O-ring for many different applications. Premium surface and rounded edges.

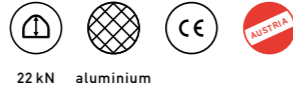

22 kN aluminium



OR..10\*

mm	A	B	C	D	E	
45	45	-	64	64	10	39



## O-RING 22 KN

Der O-RING 22 kN entspricht dem ANSI Z359.12-2019 Standard mit einer garantierten Zugkraft von 22 kN und bietet unterschiedlichste Anwendungsmöglichkeiten. Er überzeugt mit bester AUSTRIALPIN Qualität und einer hochwertigen, gefrästen Oberfläche sowie abgerundeten Kanten. Alle Ringe werden einzelstückgeprüft. The O-RING 22 kN complies with the ANSI Z359.12-2019 standard with a guaranteed tensile strength of 22 kN and offers many different application possibilities. It convinces with best AUSTRIALPIN quality and a milled premium surface as well as rounded edges. All rings are single piece tested.

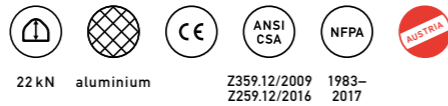

22 kN aluminium

Z359.12/2009  
Z359.12/2016

1983-  
2017



DA..OR-K

mm	A	B	C	D	E	
45	45	-	64	64	12	45

# SLIDEBLOC AND BELT BUCKLES

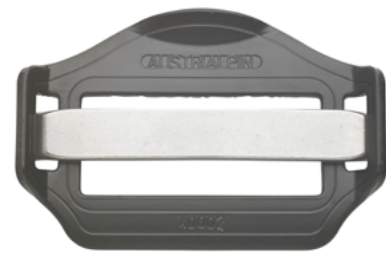

## SLIDEBLOC

Stahlschnalle mit beweglichem Mittelsteg aus Edelstahl.  
Steel buckle with flexible sliding bridge made of stainless steel.

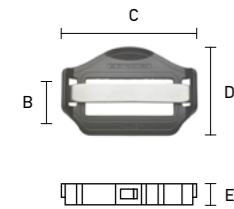
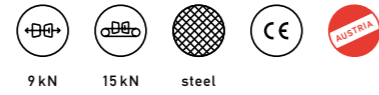

FC..SB							
mm	A	B	C	D	E	🔒	
20	-	15	38	30	5	14	
28	-	18	52	43	9	35	
33	-	18	56	42	9	38	
45	-	18	69	46	9	48	

## BELT BUCKLES

Rahmenflachschnalle und Rückfädelschnalle mit ergonomischer Wölbung. Rahmenflach- und 3-Steg Schnalle können nur gemeinsam verwendet werden. Belt buckles with ergonomically arched design, to be used in pairs only.

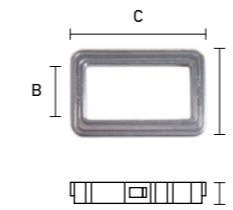
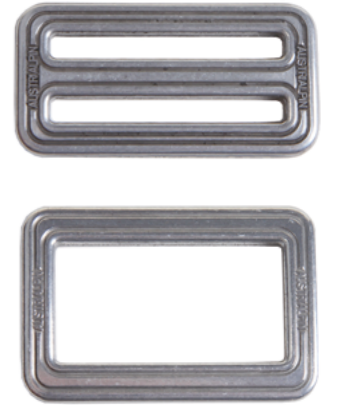
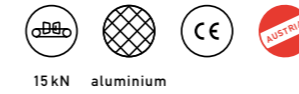

FC05/15/30/40*							
mm	A	B	C	D	E	🔒	
25	-	24	42	40	4	9	
30	-	24	47	40	4	11	
33	-	24	49	40	4	12	
45	-	24	59	40	4	13	

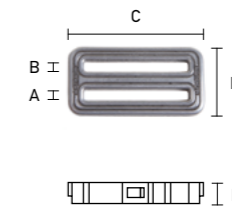

FC06/16/31/41*							
mm	A	B	C	D	E	🔒	
25	5	5	40	30	4	9	
30	5	5	45	30	4	11	
33	5	5	49	31	4	12	
45	5	5	60	31	4	14	

## BELT BUCKLES extrastrong

Starke Rahmenflachschnallen in verschiedenen Längen und Rückfädelschnalle in Aluminiumversion mit mehr Materialstärke. Rahmenflach- und 3-Steg Schnalle können nur paarweise verwendet werden. Strong belt buckles in different lengths and thicker aluminium, to be used in pairs only.

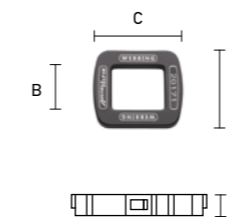

FA04B-*/FA05B-*							
mm	A	B	C	D	E	🔒	
25	-	22	43	39	5	14	
25	-	31	43	48	5	16	

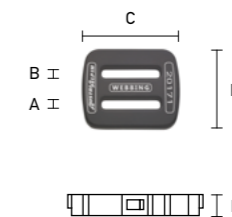

FA06B-*							
mm	A	B	C	D	E	🔒	
25	4	4	42	35	5	16	

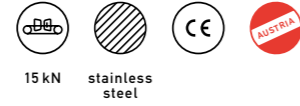

## BELT BUCKLES stainless steel

Hochwertige Rahmenflachschnalle und 3-Steg-Flachschnalle aus Edelstahl. Rahmenflach- und 3-Steg Schnalle können nur paarweise verwendet werden. Premium frame- and 2-slot-framebuckle in stainless steel, to be used in pairs only.

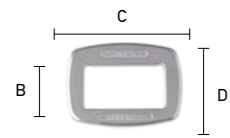

FC40VA4							
mm	A	B	C	D	E	🔒	
45	-	25	68	51	4	61	

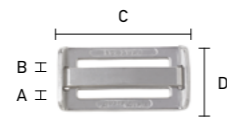

FC41VA4							
mm	A	B	C	D	E	🔒	
45	4	4	66	33	9	55	

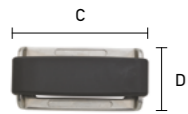
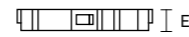
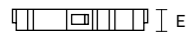

FC41VA4-F polymere anti-sliding bridge for FC41VA4							
mm	A	B	C	D	E	🔒	
45	-	-	70	21	11	7	

>> BUCKLE IS NOT INCLUDED <<



# SORTIMENTS AUSZUG PRODUKTE PRODUCTS EXTRACT



## HMS RONDO Slide Autolock with SELFIE

**Idealer Karabiner für jegliche Seilanwendungen.**  
Ideal carabiner for all-around use.

**Einfaches Öffnen und sicheres Schließen dank Slide-Autolock.**  
Easy opening and safe locking due to Slide Autolock.

**SELFIE Verdrehsicherung hält den Karabiner sicher am Platz.**  
SELFIE twist protection keeps the carabiner in place.



# KARABINER MIT VIELEN FACETTEN CARABINERS WITH MANY FACETS



Karabiner bilden das Herzstück jeder Sicherungskette und sorgen für eine sichere Verbindung. Wir fertigen Karabiner mit unterschiedlichen Verschlüssen, in vielen Formen, Größen und Farben aus Aluminium, Edelstahl und beschichtetem Stahl zu 100 Prozent in Österreich. Das hohe Maß an Qualität möchten wir nicht nur halten, sondern auch weiter ausbauen – wir arbeiten akribisch an der Verbesserung bestehender Produkte und an sinnvollen Neuentwicklungen. Unser Ziel ist es, Karabiner noch sicherer, stärker und einfacher im Handling zu machen. Carabiners are the heart of every safety chain and are key for a safe connection. We manufacture carabiners with different locks, in different forms, sizes and colors made of aluminium, stainless steel or coated steel. All carabiners are manufactured 100 % in Austria. Our goal is not only to stick to our high quality standards, but to improve them – we are constantly and meticulously working on improving our current products and on developing new innovative products. Our goal is to make carabiners even safer, stronger and easier to use.

## AUSTRIALPIN CARABINERS ARE:

- 100 % Made in Austria.
- Gefertigt aus Aluminium, Edelstahl oder beschichtetem Stahl.
- Verfügbar in den verschiedensten Formen mit unterschiedlichsten Sicherungen wie Schraubverschluss, 2-, 3- und 3-Wege+ Autolock sowie innovativen Spezialverschlüssen wie dem OVALOCK und dem Slide-Autolock.
- Verfügbar mit folgenden Veredelungen: poliert oder eloxiert, harteloxiert, ktl-beschichtet, blau-passiviert oder verzinkt.
- Verfügbar vom kleinsten MICRO bis zum OVAL XL und EXTRASTRONG mit bis zu 60 kN Bruchlast in Längsrichtung.
- Nach CE und UIAA Normen zertifiziert und entsprechen den Sicherheitsanforderungen der PSA Richtlinie (89/686/EWG Art.11B), bzw. 2016/425 (Modul D).
- 100 % Made in Austria.
- Made of aluminium, stainless steel or coated steel.
- Available in many different shapes & different locking mechanisms (screwlock, 2-, 3-way or 3-way+ autolock) as well as special, innovative locks such as OVALOCK and Slide Autolock.
- Different finishes: polished, anodized, hard-anodized, ktl-coated, electrogalvanized with blue finish, zinc-plated.
- From the little MICRO to the OVAL XL and EXTRASTRONG with up to 60 kN in strength.
- Tested according to CE and UIAA standards and correspond with the PPE Directive 89/686/EEC Art.11B or 2016/425 (modul D).

## CHOOSING THE RIGHT CARABINER

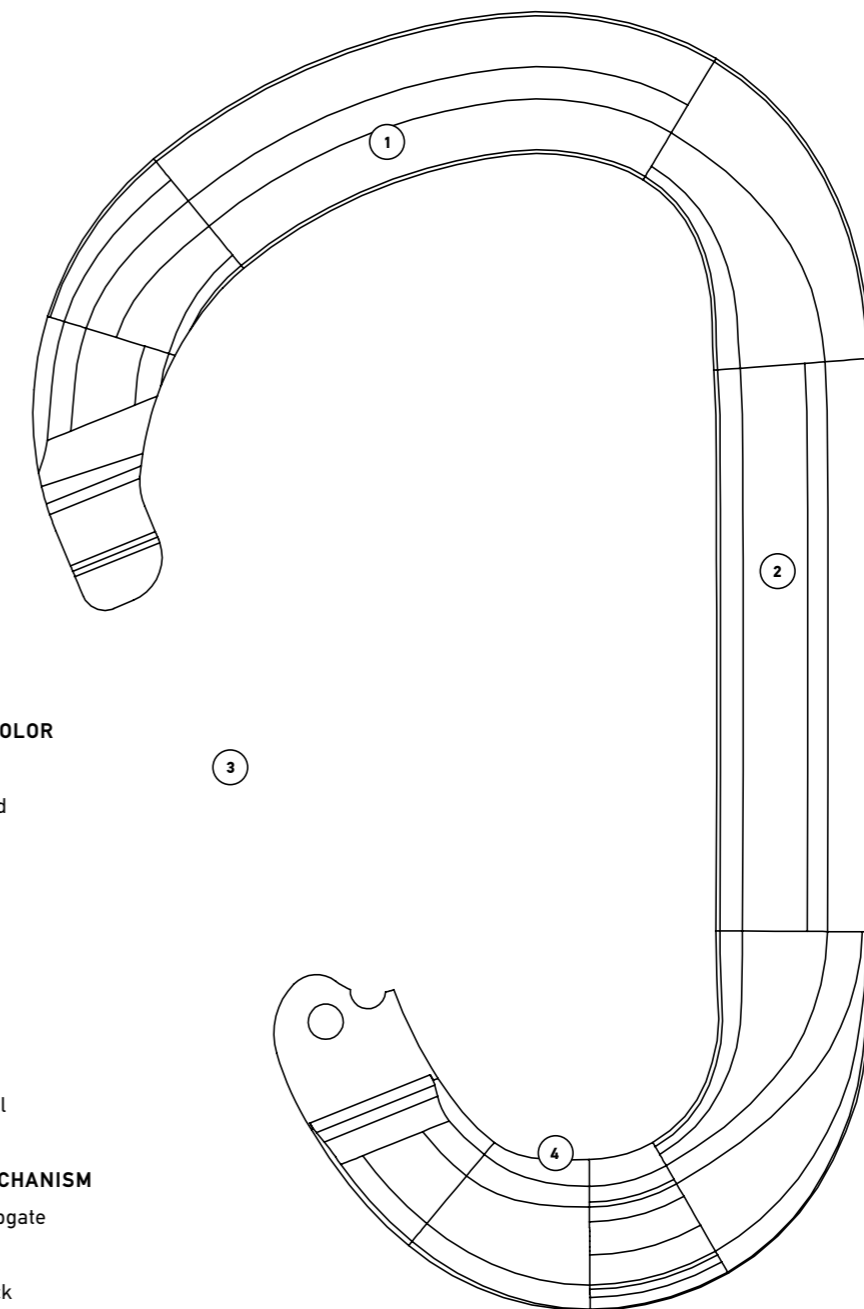

- 1 COATING & COLOR**  
 anodized  
 hard-anodized  
 polished  
 zinc-plated  
 ktl-coated
- 2 MATERIAL**  
 aluminium  
 steel  
 stainless steel
- 3 LOCKING MECHANISM**  
 wiregate/snapgate  
 screwlock  
 2-way autolock  
 3-way autolock  
 3-way+ autolock  
 ovalock  
 slide autolock
- 4 SHAPE**  
 hms  
 oval  
 d-shape  
 and many more special shapes

## NON-LOCKING CARABINERS | SHAPES AND USAGE

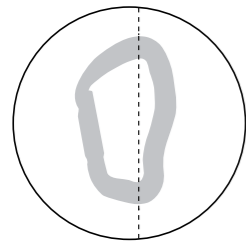

### D-Form D-shape

D-förmige Karabiner sind effizient und stark und bieten vielseitige Einsatzmöglichkeiten. D-shaped carabiners are efficient and strong and offer a wide variety of application possibilities.

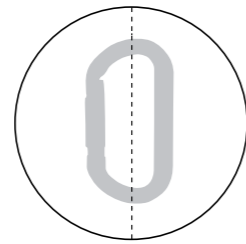

### Ovale Form Oval shape

Konzipiert als Universalkarabiner oder für die Verwendung mit Umlenkrollen. Designed for universal usage or for use with pulleys.

## NON-LOCKING CARABINERS | GATES

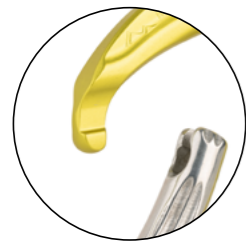

### Schnapper Snappgate

Keylock-Verschlüsse haben keine Nase und minimieren so das Sicherheitsrisiko beim Ein- und Aushängen. Keylock carabiners have no hook, which keeps the risk when clipping or unhooking to a minimum.



### Drahtbügel Wiregate

Drahtbügel-Verschlüsse sind leichter und weniger anfällig gegenüber Verschmutzung oder Vereisung. Wiregate carabiners are lighter and less prone to dirt or freezing.

## COLORS

Die Farbpalette unserer Karabiner ist sehr breit. Darüber hinaus bieten wir für eine noch längere Lebensdauer auch einige hartbeschichtete Karabiner an. We offer a wide color range for many of our carabiners. In addition, some carabiners are hard-anodized for even longer use.

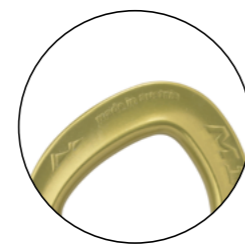
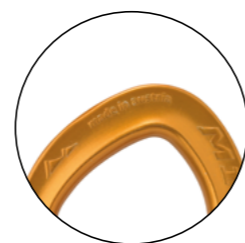
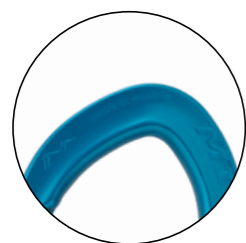

## LOCKING CARABINERS | SHAPES AND USAGES

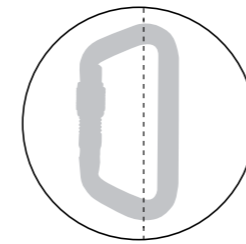

### D-Form D-shape

D-förmige Karabiner sind effizient und stark und bieten vielseitige Einsatzmöglichkeiten. D-shaped carabiners are efficient and strong and offer a wide variety of application possibilities.

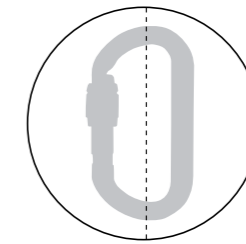

### Ovale Form Oval shape

Konzipiert als Universalkarabiner oder für die Verwendung mit Umlenkrollen. Designed for universal usage or for use with pulleys.

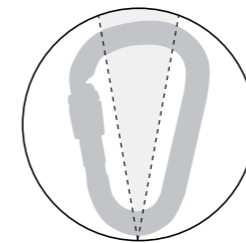

### Birnenform Pear-shape

Große Karabinerform mit breiter Seilaufnahme und rundem Querschnitt zum Sichern mit Halbmastwurf oder zum Einhängen von Ausrüstung. Big carabiner shape with round profile for belaying with the munter hitch or to secure climbing gear.

## LOCKING CARABINERS | LOCKING MECHANISMS

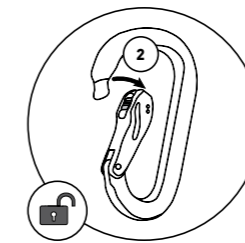
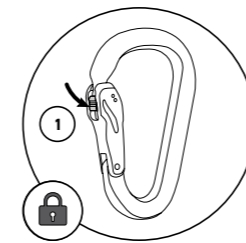

### Slide-Autolock Slide Autolock

Verbindet die Einfachheit eines Schnappers mit der Sicherheit eines Verschlusskarabiners. Einfach mit Finger über den Slider fahren und öffnen. Combines the simplicity of a snappgate with the safety of a locking carabiner. Just slide your finger to open!

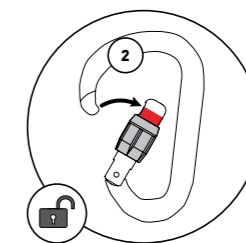
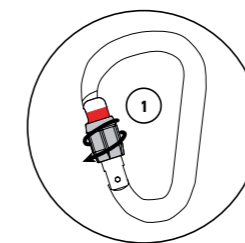
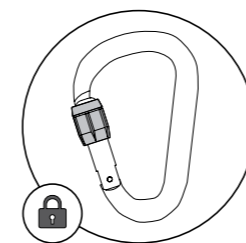

### Schraubverschluss Screwlock

Leichtgängig wegen hohem Schwinggewicht, z.T. selbstreinigend. Easy handling because of high swing weight, partly self-cleaning.

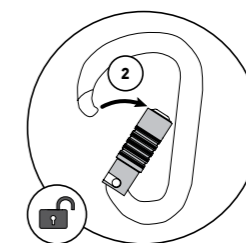
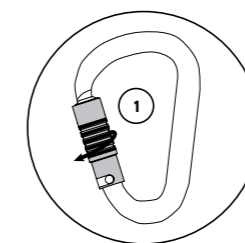
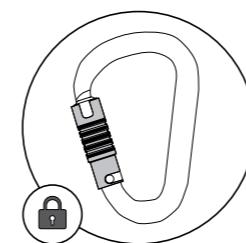

### 2-Wege-Autolock 2-Way Autolock

Rolle drehen und Schnapper aufdrücken: wenn es besonders schnell gehen muss. If time is important and you need to be really fast: Turn barrel and push gate open.

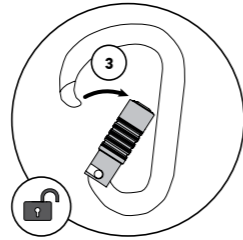
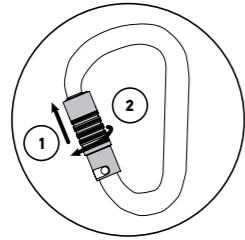
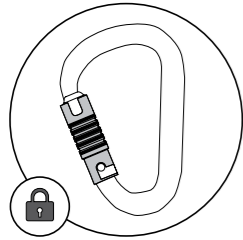

### 3-Wege-Autolock 3-Way Autolock

Rolle nach oben drücken, drehen und Schnapper aufdrücken. Ein Weg mehr = ein zusätzliches Plus an Sicherheit. Press barrel upwards, turn and push gate open. One additional = a safety plus.

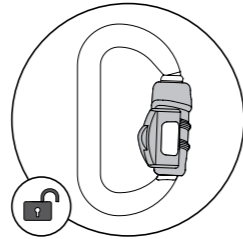
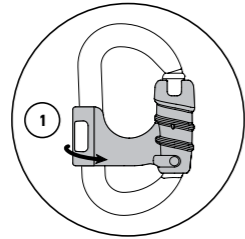
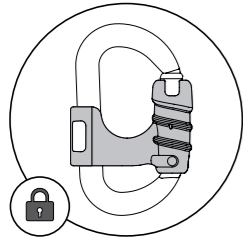

### Ovalock Ovalock

Push-to-open-Funktion, erlaubt nur zwei Möglichkeiten: offen oder geschlossen. Absolut einfaches Handling, verhindert gefährliche Querbelastungen. Push-to-open allows two options: opened or closed. Easy-to-use, prevents the dangers of cross-loading.

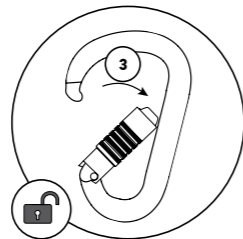
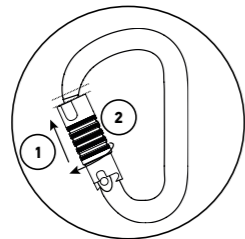
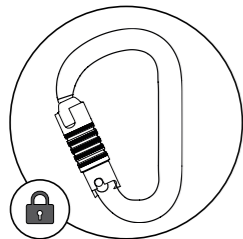

### 3-Wege+ Autolock 3-way+ Autolock

Rolle nach oben drücken, drehen und Schnapper aufdrücken oder Rolle nach oben drücken und in die entgegengesetzte Richtung drehen. So blockiert der Schnapper. Kein versehentliches Öffnen oder Aufvibriern. Press barrel upwards, turn and push gate open. Alternatively press barrel upwards, turn it in opposite direction and lock it into the notch. Gate is blocked and cannot open accidentally or due to vibration.

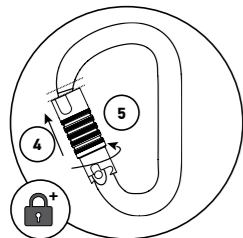

## BENEFITS FROM STOCK



### GATE RED (GR) Red Visual Safety Band

Die rote Markierung ist sichtbar? ACHTUNG! Schraubverschluss ist nicht verriegelt! Red marking is visible? ATTENTION! Screwgate is not locked!



### UNIQUE IDENTIFICATION NUMBER (ID)

Jeder Karabiner erhält eine eigene individuelle Nummer. Dies ermöglicht eine eindeutige Identifikation des Karabiners. Each carabiner gets an individual number. This enables a clear identification of the carabiner.

 **XX/XXXX** **KR** **02688** month/year of production, letter 1 and 2 of item no., unique number



### GATE RED and ID NUMBER (GI)

Unsere Schraubkarabiner mit GI in der Artikelnummer haben sowohl ein GATE RED als auch eine ID Nummer. All carabiners with GI have the red visual marking and an ID number.

## ADDITIONAL BENEFITS



### MOQ Guidelines for Special Editions

- climbing carabiners | 100 pcs per order and type
- air sports carabiners | 1000 pcs per order, type and color
- COBRA® buckles | 500 pcs per order, type and color
- COBRAFRAMES | 1000 pcs per order, type and color

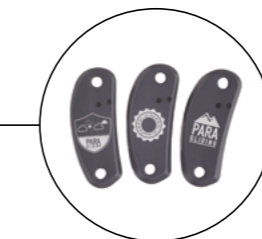
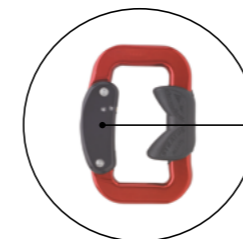

### Laser Marking for Aluminium Products

Einzelstückmarkierung und Personalisierung möglich. Single piece marking or personalisation possible.



### Pin Marking for Steel Products

Einzelstückmarkierung und Personalisierung möglich. Single piece marking or personalisation available.



# KARABINERTYPEN GRÖSSENVERGLEICH TYPES OF CARABINERS SIZE COMPARISON

## MICRO

Aluminium or stainless steel

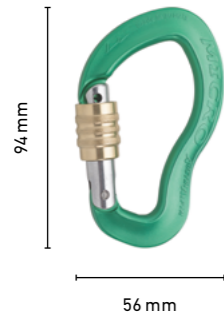

## ELEVEN

Aluminium

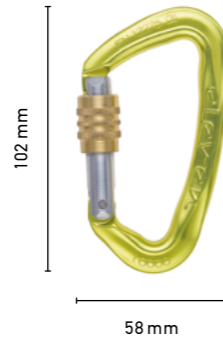

## ROCKIT/ROCKET

Aluminium



## STRATUS

Aluminium or stainless steel

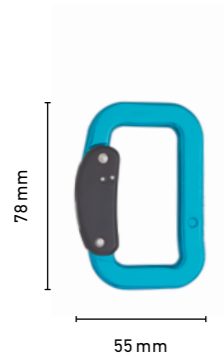

## POWERFLY

Stainless steel

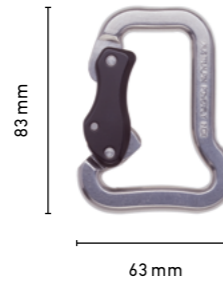

## HMS MINI.MI

Aluminium

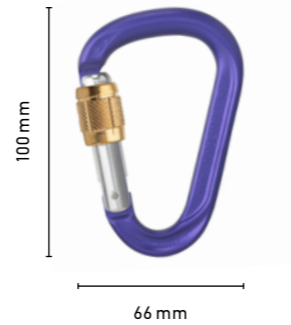

## HMS RONDO

Aluminium

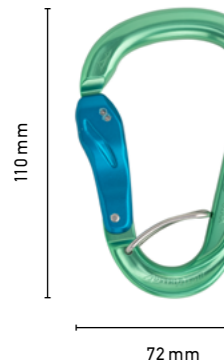

## OVALO

Aluminium

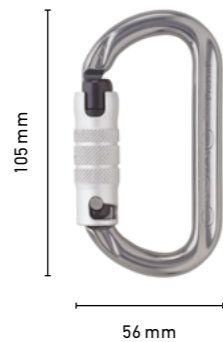

## OVALO OVALOCK

Aluminium

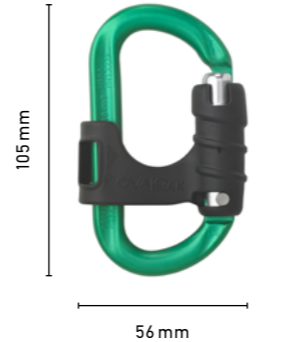

—  
austrialpin.at

Auf unserer Website erhältst du einen Überblick über die gesamte AUSTRIALPIN Produktpalette inklusive Karabinern, Sicherungsgeräten, Seilen und vielen weiteren Sicherheitsprodukten. Have a look at our website and find out more about the complete AUSTRIALPIN product range like belay devices, carabiners, ropes and many other safety products.

## D ASYMM

Stainless steel or steel



## ASYMM OVAL XL

Steel



## ASYMM OVAL

Steel



## D SYMM

Steel

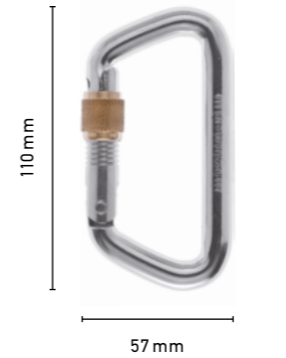

## SYMM OVAL

Steel

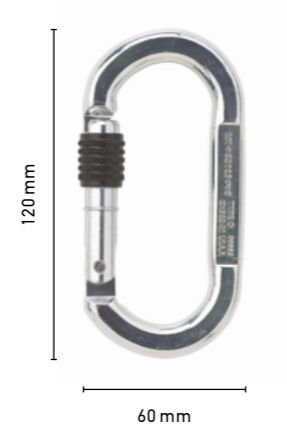

## 2800 EVO

Aluminium



## PIRUM

Aluminium

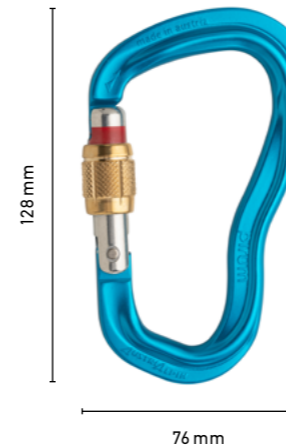

# SORTIMENTS AUSZUG KARABINER

## CARABINER EXTRACT

### HMS RONDO

Der HMS RONDO erfüllt alle Anforderungen hinsichtlich einfachen Handlings und fühlbarer Sicherheit. Der runde Querschnitt am oberen Schenkel verhindert eine durch Seilreibung verursachte Kantenbildung und unterstützt zudem eine flüssige Seilführung. Der ideale Karabiner für jegliche Anwendung mit dem Seil. The design of the HMS RONDO prevents the build up of sharp edges from rope friction. The round profile allows for fluid rope management making the HMS the ideal carabiner for all-around use.



#### HMS RONDO GI Screwlock

Der RONDO Schraubkarabiner mit leichtläufiger Messingrolle und roter Karabiner-offen-Markierung und individueller Nummerierung. Selbstreinigender Verschluss durch spezielle Fräsung im Gewinde. RONDO with self-cleaning screwlock with smooth-running brass sleeve, red visual safety band and unique identification number.

ART.NO.	MATERIAL & FINISH	FEATURES
KR13B-R-GI	● alu anodized	gate red, unique ID

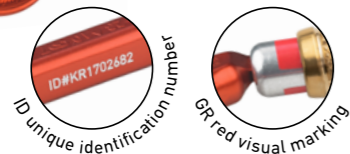

#### HMS RONDO Screwlock with SELFIE

RONDO Schraubkarabiner mit leichtläufiger Messingrolle und SELFIE-Verdrehsicherung, welche die Anseilschleife umschließt und somit den Karabiner in Position hält. Selbstreinigender Verschluss durch spezielle Fräsung im Gewinde. RONDO with self-cleaning brass sleeve screwlock and SELFIE twist protection; captures the belay loop and keeps the carabiner in place.

ART.NO.	MATERIAL & FINISH	FEATURES
KR13B-BS	● alu anodized	twist protection



### HMS RONDO ID 3-Way Autolock

Der RONDO als 3-Wege-Autolock Karabiner. Zum Öffnen: heben, drehen und drücken; mit individueller Nummerierung. 3-way autolock carabiner. To open: lift, twist and push; with unique identification number.

ART.NO.	MATERIAL & FINISH	FEATURES
KR35B3-R-ID	● alu anodized	unique ID

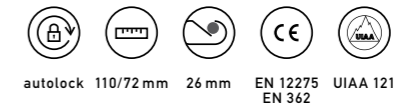

### HMS RONDO 3-Way+ Autolock

Der RONDO als 3-Wege+ Autolock Karabiner. Aus der normalen Position lässt er sich wie ein 3-Wege Karabiner durch heben, drehen und drücken des Verschlusses öffnen. Darüber hinaus bietet er eine zusätzliche Verriegelungsfunktion, die ein ungewolltes Öffnen nahezu unmöglich macht. Die neue, überarbeitete Version bietet eine verbesserte Handhabung der Verschlussfunktionen. The RONDO with a 3-way+ autolock. When locked, this mechanism functions as a normal 3-way autolock (to open: lift, twist and push). The PLUS function adds a fully locked position that makes unintentional opening virtually impossible. The new, revised version offers improved handling of the locking functions.



ART.NO.	MATERIAL & FINISH	FEATURES
KR52B-Y	● alu anodized	safelock

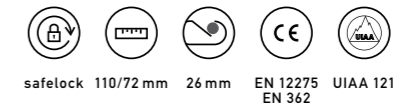
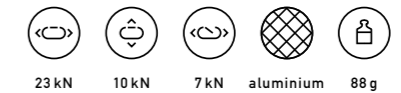

# THE SLIDE-AUTOLOCK: FAST. EASY. SAFE.

THE WORLD'S  
FASTEST  
AUTOLOCK.

## VORTEILE BENEFITS

Der Slide-Autolock erfüllt alle Anforderungen hinsichtlich schnellen und einfachen Handlings und fühlbarer Sicherheit: Kein umständliches Schrauben oder Drehen des Verschlusses mehr! Der Slide-Autolock lässt sich bequem durch Druck mit einem Finger auf den eingelassenen Messing-Slider öffnen. Beim Loslassen des Schnappers verriegelt dieser automatisch. Anwender, die auf schnelles und einfaches Handling Wert legen, werden diesen Verschluss lieben! The Slide Autolock meets all expectations concerning fast and easy handling and tangible safety: Forget inconvenient screwing or turning of the gate! The carabiner can be opened easily by just pressing the embedded brass slider. The gate automatically locks when releasing the slider. Users who are looking for an easy-to-use and safe carabiner will love the Slide Autolock.

- Schnelles Öffnen durch gezielten Fingerdruck auf den Slider.
- Einhändige Bedienung möglich.
- Gleichermaßen für Rechts- und Linkshänder geeignet.
- Abgesenkte Positionierung des Sliders verhindert ungewolltes Öffnen.
- Kein Öffnen durch Vibration möglich.
- Der Verschluss blockiert bei Druck auf dem Schnapper.
- Fast and easy opening by pressing the embedded brass slider.
- One-handed handling possible.
- Suitable for both: right- and left-handers.
- Through the embedded positioning of the button, unintended opening of the gate is not possible.
- No opening due to vibration possible.
- The locking mechanism doesn't function when there is pressure on the gate.

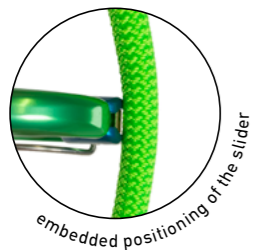

## HMS RONDO Slide Autolock

Der HMS RONDO mit dem schnellsten Karabiner-Verschluss der Welt – dem Slide-Autolock! Dieser erfüllt alle Anforderungen hinsichtlich einfachen Handlings und fühlbarer Sicherheit. Die schwarze Version kommt mit einer abriebfesten Hard Coat Beschichtung für eine noch längere Lebensdauer. The HMS RONDO with the fastest locking mechanism worldwide – the Slide Autolock! The Slide Autolock meets all expectations concerning easy handling and tangible safety. The black version of the carabiner is hard-anodized. This makes the carabiner more abrasion-resistant for an even longer durability.



ART.NO.	MATERIAL & FINISH	FEATURES
KR43H-X	● alu hard-anodized	a much longer lifetime, all black
KR43B-N	● alu anodized	
KR43B-N	● alu anodized	

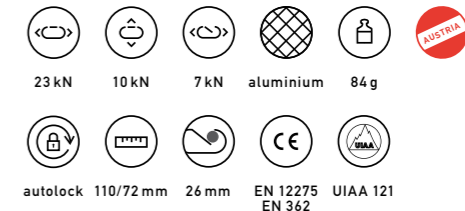

## HMS RONDO Slide Autolock with SELFIE

Der HMS RONDO mit dem schnellsten Karabiner-Verschluss der Welt – dem Slide-Autolock! Dieser erfüllt alle Anforderungen hinsichtlich einfachen Handlings und fühlbarer Sicherheit. Die SELFIE Verdrehsicherung umschließt die Anseilschleife und hält den Karabiner so in Position für noch mehr Sicherheit und Komfort. Die schwarze Version kommt mit einer abriebfesten Hard Coat Beschichtung für eine vielfach längere Lebensdauer. The HMS RONDO with the fastest locking mechanism worldwide – the Slide Autolock! The Slide Autolock meets all expectations concerning easy handling and tangible safety. The SELFIE twist protection captures the belay loop and keeps the carabiner in place for more safety and comfort. The black version of the carabiner is hard-anodized. This makes the carabiner more abrasion-resistant for an even longer durability.

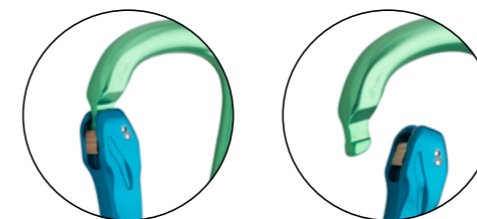

ART.NO.	MATERIAL & FINISH	FEATURES
KR43H-XS	● alu hard-anodized	a much longer lifetime, twist protection
KR43B-NS	● alu anodized	twist protection



## OVAL CARABINERS

Die ovale Form begünstigt in jeder Situation die optimale Ausrichtung des Karabiners nach der Längsachse und vermindert somit gefährliche Querbelastungen. Durch den runden Querschnitt der OVALO Karabiner wird zusätzlich das Seilhandling optimiert. Oval shaped carabiners find their optimal position in every situation, thus never compromising their maximum strength. There is hardly any possibility these carabiners turn on their side and are weighted in a dangerous cross-wise direction. In addition, the round profile at the upper and lower end of the OVALO carabiners optimizes rope handling.



### OVALO GI Screwlock

Ovalkarabiner mit leichtläufigem Schraubverschluss aus Messing und rundem Querschnitt, roter Karabiner-Offen-Markierung und individueller Nummerierung. Selbstreinigender Verschluss durch spezielle Fräsung im Gewinde. Oval shaped carabiner with self-cleaning brass sleeve screwlock and round profile, red visual safety band and unique identification number.

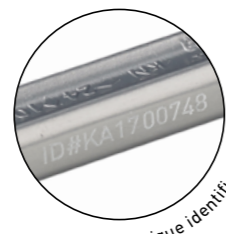

ID unique identification number

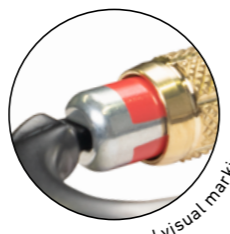

GR red visual marking

ART.NO.	MATERIAL & FINISH	FEATURES
KA13B-B-GI	alu anodized	gate red, unique ID
KA13B-G-GI	alu anodized	gate red, unique ID
KA13B-R-GI	alu anodized	gate red, unique ID
KA13B-Z-GI	alu anodized	gate red, unique ID



### OVALO ID 3-Way Autolock

Ovalkarabiner als 3-Wege-Autolock mit rundem Querschnitt und individueller Nummerierung. Ovale shaped carabiner with 3-way autolock and unique identification number.

ART.NO.	MATERIAL & FINISH	FEATURES
KA35B3-G-ID	alu anodized	unique ID

ID unique identification number

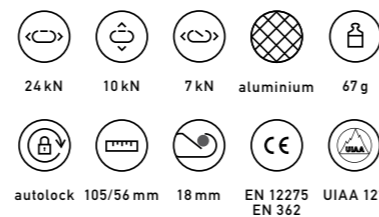

## SYMM OVAL Screwlock steel

Symmetrisch ovaler Stahlkarabiner mit Schraubverschluss. Symmetric oval shaped steel carabiner with screwlock.

ART.NO.	MATERIAL & FINISH	FEATURES
TK11AK	steel zinc-plated	class M

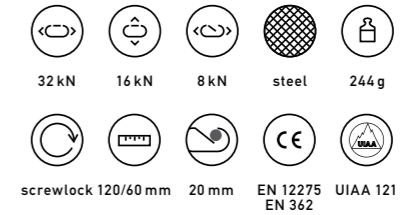

## SYMM OVAL 3-Way Autolock steel

Symmetrisch ovaler Stahlkarabiner mit 3-Wege-Autolock. Symmetric oval shaped steel carabiner with 3-way autolock.

ART.NO.	MATERIAL & FINISH	FEATURES
TK35AK3	steel zinc-plated	class M

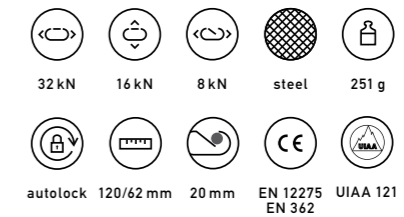

## ASYMM OVAL Screwlock steel

Asymmetrisch ovaler Stahlkarabiner mit Schraubverschluss. Asymmetric oval shaped steel carabiner with screwlock.

ART.NO.	MATERIAL & FINISH	FEATURES
TF11AK	steel zinc-plated	class M



## ASYMM OVAL 3-Way Autolock steel

Asymmetrisch ovaler Stahlkarabiner mit 3-Wege-Autolock. Asymmetric oval shaped steel carabiner with 3-way autolock.

ART.NO.	MATERIAL & FINISH	FEATURES
TF35AK3	steel zinc-plated	class M





## ASymm OVAL XL Screwlock steel

Asymmetrisch ovaler Stahlkarabiner im XL-Format mit 30 mm Karabineröffnung und Messingrolle.  
Asymmetrical oval shaped steel carabiner in XL, 30 mm gate opening with brass sleeve.

ART.NO.	MATERIAL & FINISH	FEATURES
TP11AK	● steel zinc-plated	class M, X-large



## ASymm OVAL XL 3-Way Autolock steel

Asymmetrisch ovaler Stahlkarabiner im XL-Format mit 29 mm Karabineröffnung und Messinghülse.  
Asymmetrical oval shaped steel carabiner in XL, 29 mm gate opening with brass sleeve.

ART.NO.	MATERIAL & FINISH	FEATURES
TP35AK3	● steel zinc-plated	class M, X-large



## D-SHAPED & BIG-SIZED LOCKING CARABINERS

Karabiner in D-Form zeichnen sich durch hervorragende Bruchlastwerte zwischen 28 und 60 kN aus. In den Reihen der D-Form-Karabiner befinden sich auch viele große Verschlusskarabiner wie der PIRUM. Diese sind speziell für Anwendungen konzipiert, die etwas mehr Platz brauchen, beispielsweise bei der Verwendung als Zentralkarabiner oder bei dickeren Seildurchmessern. Die überdurchschnittlich große Schnapperöffnung schützt die Finger und minimiert selbst bei schnellem Klippen die Einklemmgefahr. D-shaped carabiners are characterized by a very high breaking load between 28 and 60 kN. Among the D-shaped carabiners are also many big-sized locking carabiners like the PIRUM. Big-sized locking carabiners are specially designed for situations where more space is needed, for example as a central carabiner or for working with ropes with thicker diameters. With a wide gate clearance, these carabiners minimize the risk of getting fingers caught while clipping.

## PIRUM GI Screwlock

XL-Schraubkarabiner mit großer Schnapperöffnung, leichtläufiger Messingrolle, roter Karabiner-Offen-Markierung und individueller Nummerierung. Selbstreinigender Verschluss durch spezielle Fräsung im Gewinde. Durch seinen anatomisch geformten Rücken liegt der PIRUM besonders natürlich in der Hand und hat mit 30 kN ausgezeichnete Festigkeitswerte. Big-sized screwlock carabiner with wide gate opening, smooth and self-cleaning running brass sleeve, red visual safety band and unique identification number. The shape of the PIRUM is specially designed to lie naturally in your hand without reducing its strength: It is certified for 30 kN.

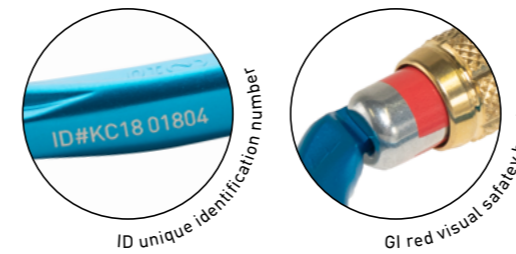

ART.NO.	MATERIAL & FINISH	FEATURES
KC13B-B-GI	● alu anodized	gate red, unique ID

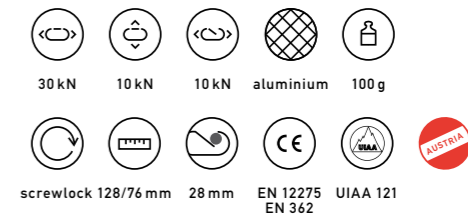



## PIRUM GI Screwlock

XL-Schraubkarabiner mit großer Schnapperöffnung, roter Karabiner-Offen-Markierung und individueller Nummerierung. Selbstreinigender Verschluss durch spezielle Fräsung im Gewinde. Durch seinen anatomisch geformten Rücken liegt der PIRUM besonders natürlich in der Hand und hat mit 30 kN ausgezeichnete Festigkeitswerte. Big-sized carabiner with self-cleaning screwlock, wide gate opening, red visual safety band and unique identification number. The shape of the PIRUM is specially designed to lie naturally in your hand without reducing its strength. It is certified for 30 kN.



ID unique identification number



GI red visual safety band

ART.NO.	MATERIAL & FINISH	FEATURES
KC11B-X-GI	● alu anodized	all black, gate red, unique ID



## PIRUM ID 2-Way Autolock

2-Wege-Autolock Karabiner – drehen und drücken – im XL-Format mit großer Schnapperöffnung und individueller Nummerierung. Durch seinen anatomisch geformten Rücken liegt der PIRUM besonders natürlich in der Hand und hat mit 30 kN ausgezeichnete Festigkeitswerte. Big-sized 2-way autolock carabiner – twist and push – with wide gate opening and unique identification number. The form of the PIRUM is specially designed to lie naturally in your hand without reducing its strength. It is certified for 30 kN.



ID unique identification number

ART.NO.	MATERIAL & FINISH	FEATURES
KC35B-G-ID	● alu anodized	unique ID



## PIRUM ID 3-Way Autolock

3-Wege-Autolock Karabiner – heben, drehen und drücken – im XL-Format mit großer Schnapperöffnung und individueller Nummerierung. Durch seinen anatomisch geformten Rücken liegt der PIRUM besonders natürlich in der Hand und hat mit 30 kN ausgezeichnete Festigkeitswerte. Big sized 3-way autolock carabiner – lift, twist and push – with wide gate opening and unique identification number. The form of the PIRUM is specially designed to lie naturally in your hand without reducing its strength. It is certified for 30 kN.



ID unique identification number



ART.NO.	MATERIAL & FINISH	FEATURES
KC35B3-G-ID	● alu anodized	unique ID
KC35B3-X-ID	● alu anodized	all black, unique ID

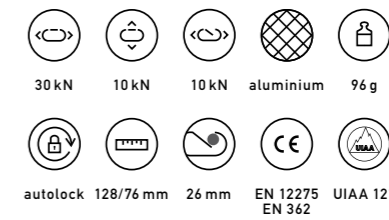

## 2800 EVO Screwlock

Großer Aluminiumkarabiner in HMS Form mit Schraubverschluss, weiter Schnapperöffnung und hohen Festigkeiten. Large and strong aluminium carabiner in HMS shape with large gate opening.

ART.NO.	MATERIAL & FINISH	FEATURES
KW11A	● alu polished	
KW11B-X	● alu anodized	all black

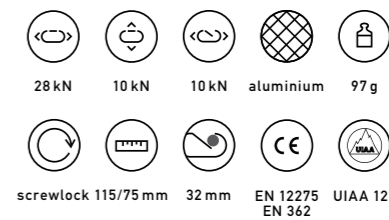

## 2800 EVO 3-Way Autolock

Großer Aluminiumkarabiner in HMS Form mit 3-Wege-Autolock, weiter Schnapperöffnung und hohen Festigkeiten. Large and strong aluminium 3-way autolock carabiner in HMS shape with large gate opening.

ART.NO.	MATERIAL & FINISH	FEATURES
KW35A3	● alu polished	
KW35B3	● alu anodized	





### D SYMM Screwlock steel

Starke Karabinerform aus Stahl mit Schraubverschluss.  
Strong carabiner shape with screwlock, made of steel.

ART.NO.	MATERIAL & FINISH	FEATURES
TL61A	● steel zinc-plated	extrastrong

screwlock 110/57 mm 20 mm EN 12275 EN362



### D ASYMM Screwlock steel

Starker Stahlkarabiner mit Schraubverschluss.  
Strong carabiner shape with screwlock, made of steel.

ART.NO.	MATERIAL & FINISH	FEATURES
TN11AK	● steel zinc-plated	class M
TN11AK-X	● steel ktl coated	all black, class M

screwlock 113/70 mm 25 mm EN 12275 EN 362 UIAA 121



### D ASYMM Screwlock stainless steel

Starker Edelstahlkarabiner mit Schraubverschluss, mit oder ohne Splint verfügbar.  
Strong carabiner shape with screwlock, made of stainless steel. Available with or without splint.



ART.NO.	MATERIAL & FINISH	FEATURES
TN11AK-I	● stainless steel pol.	class M
TN11AK-IS	● stainless steel pol.	splint, class M

screwlock 113/70 mm 25 mm EN 12275 EN 362 UIAA 121

### D ASYMM 3-Way Autolock stainless steel

Starker Edelstahlkarabiner mit 3-Wege-Autolock, mit oder ohne Splint verfügbar.  
Strong carabiner shape with 3-way autolock, made of stainless steel. Available with or without splint.



ART.NO.	MATERIAL & FINISH	FEATURES
TN35AK3-I	● stainless steel pol.	class M
TN35AK3-IS	● stainless steel pol.	splint, class M

autolock 113/70 mm 25 mm EN 12275 EN 362 UIAA 121

### D ASYMM 3-Way Autolock steel

Starker Stahlkarabiner mit 3-Wege-Autolock.  
Strong carabiner shape with 3-way autolock, made of steel.



ART.NO.	MATERIAL & FINISH	FEATURES
TN35AK3	● steel zinc-plated	class M

autolock 113/70 mm 25 mm EN 12275 EN 362 UIAA 121

# FLUGSPORT KARABINER

## AIR SPORTS CARABINERS



**ROCKET**  
Slide Autolock



**STRATUS SLIM**  
Slide Autlock



**STRATUS**  
Slide Autolock



**POWERFLY**  
Slide Autolock

Informationen zu unseren Flugkarabinern findest du auf [austrialpin.at](http://austrialpin.at). Please find all information about our air sports carabiners on [austrialpin.at](http://austrialpin.at)

# ROLLEN

## PULLEYS

### Pulley

Seitrolle mit aufklappbaren Seitenlaschen und Kunststoffrolle.  
With hinged side blades and synthetic pulley.

ART.NO.	MATERIAL & FINISH	LOAD CAPACITY	STRENGTH
AL02A	● alu polished, plastic	2x2 kN	15 kN
AL02B	● alu anodized, plastic	2x2 kN	15 kN



### Straight Pulley

Zwei individuelle Gleitlager ermöglichen eine axiale und radiale Lagerung. Diese verbessern nicht nur die Rolleigenschaften, sondern verringern auch die Geräusentwicklung. Die Kanten der Rolle werden nunmehr gefast. Durch die dadurch entstehenden Einlaufschrägen kann die Flugrolle nun leinenschonender zum Einsatz gebracht werden und verursacht weniger Verschleiß. Bei diesem Modell ist die Achse gerade ausgerichtet. Das Gehäuse ist wie gehabt aus Aluminium, die 2-fach gelagerte Rolle aus hochwertigem Messing. The pulley now has two plain bearings, which provide enhanced axial and radial support. This results in improved pulley characteristics and reduced noise. The edges of the brass wheel have been chamfered to reduce wear on the line. This new pulley has a straight-aligned axle and is made from high-quality brass with a light-weight aluminum housing. Experience the future of pulley technology with the high-performance Pulley PRO XS.

ART.NO.	FEATURES	MATERIAL	SLOT	WEIGHT
FL32AG	standard	aluminium, brass	8 mm	8 g

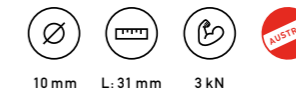

NEW

### STRAIGHT PULLEY

Rolle mit gerader Achsenausrichtung. Gehäuse aus Aluminium mit hochwertiger Messingrolle.  
Pulley with straight rollaxis. Body made of aluminium with premium brass roll.

ART.NO.	FEATURES	MATERIAL	SLOT	WEIGHT
FL12A	standard	aluminium, brass	15 mm	9,5 g





**ROLLAXIS OFFSET 90° PULLEY**

Achse 90° gedreht. Gehäuse aus Aluminium mit hochwertiger Messingrolle.  
Rollaxis offset 90°. Body made of aluminium with premium brass roll.



ART.NO.	FEATURES	MATERIAL	SLOT	WEIGHT
FL33A	XS	aluminium, brass	9 mm	7 g
FL13A	standard	aluminium, brass	15 mm	9,5 g



L: 29 mm



photocredit: Armin Zorn



# SORTIMENTS AUSZUG SICHERUNGS- UND ABSEILGERÄTE BELAY AND RAPPEL DEVICES EXTRACT



NEW

## GOLD FISH Amplified Braking Device Set with HMS RONDO Slide Autolock SELFIE

Autotuber-Set mit GOLD FISH und RONDO Slide-Autolock Karabiner für eine absolut einfache Handhabung ohne Sicherheitseinbußen. Der Karabiner ist hartbeschichtet für eine vielfach längere Lebensdauer. Dank der selbstständigen Blockierfunktion des GOLD FISH, der vereinfachten Funktionsweise des Karabiners und der integrierten SELFIE-Verdrehsicherung eignet sich dieses Set für all diejenigen, die ein zuverlässiges Sicherungsgerät suchen. Autotube set includes GOLD FISH autotube and RONDO Slide Autolock carabiner for easy handling without sacrificing safety. The carabiner is hard-anodized for a much longer lifetime. Thanks to its automatic locking function and the easy-to-use carabiner with the integrated SELFIE twist protection, this autotube set is perfect for everyone who is looking for a reliable belay device.

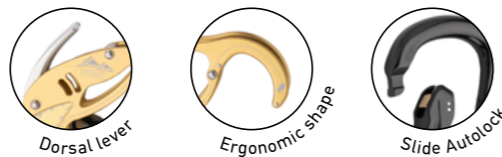

ART.NO.	MATERIAL & FINISH	FEATURES
AB24Y-SET	● alu anodized, hard-anodized	PATENTED incl. HMS RONDO Slide Autolock SELFIE

TECH. SPECS. | FISH & SET



TECH. SPECS. | RONDO

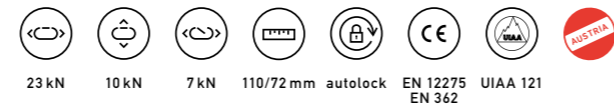

## NEMO Figure-8

Sehr kleiner und leichter Abseilachter, besonders geeignet für den Behelfseinsatz mit dünnen 6 mm Leinen. Small and lightweight figure-8. Ideal for the alternative or emergency use (e.g. rappelling) with thin 6 mm cords.

ART.NO.	MATERIAL & FINISH	FEATURES
AF09B-B	● alu anodized	9 different grades of rope friction and 3 options for locking



>> tested in combination with AUSTRIALPIN 22 kN CORE.DY only <<

## NEMO FIX Figure-8

Sehr kleiner und leichter Abseilachter, besonders geeignet für den Behelfseinsatz mit dünnen 6 mm Leinen. Die Gummifixierung verhindert das Verrutschen des Karabiners und sorgt für geräuscharme Benützung. Small and lightweight figure-8. Ideal for the alternative or emergency use (e.g. rappelling) with thin 6 mm cords. Rubber fixation prevents the carabiner from slipping out of position and guarantees soundless rappeling.

ART.NO.	MATERIAL & FINISH	FEATURES
AF09B-X-F	● alu anodized	incl. rubber fixation



## NO.MAD Figure-8

Speziell geformter Abseilachter, besonders geeignet für Canyoning und Seilbergungen. Die Gummifixierung verhindert das Verrutschen des Achters im Karabiner und sorgt für geräuscharme Benützung. Specially formed figure-8, ideal for canyoning and rope rescue. Rubber fixation prevents the carabiner from slipping out of position and guarantees soundless rappeling.

ART.NO.	MATERIAL & FINISH	FEATURES
AF10A-F	● alu polished	9 different grades of rope friction and 3 options for locking, incl. rubber fixation
AF10B-Y-F	● alu anodized	
AF10B-X-F	● alu anodized	



## ROPE.X Figure-8

Speziell geformter Abseilachter, besonders geeignet für Canyoning und Seilbergungen. Das ideale Tool für den Guide. Specially formed figure-8, ideal for canyoning and rope rescue. The ideal tool for guides.

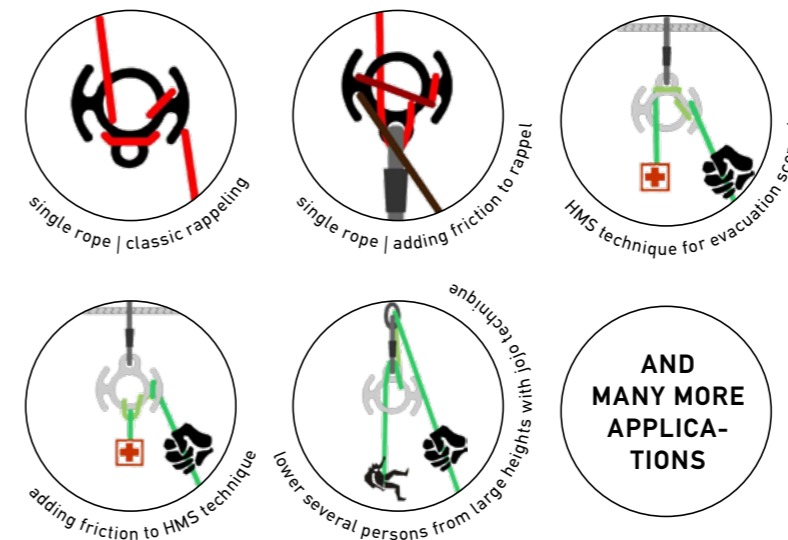

AND MANY MORE APPLICATIONS

ART.NO.	MATERIAL & FINISH	FEATURES
AF50C	● alu anodized	many different grades of rope friction and options for locking
AF50H-X	● alu hard anodized	a much longer lifetime, many different grades of rope friction and options for locking





## FIGURE-8

Geschmiedeter Standard Abseilachter.  
Forged figure-8.

ART.NO.	MATERIAL & FINISH	FEATURES
AF02B-B	● alu anodized	
AF02B-O	● alu anodized	
AF02B-R	● alu anodized	
AF02B-X	● alu anodized	



132/75 mm 7,3-10,5 mm 110 g EN 15151-2 UIAA 129



## Maillon Rapides

Die originalen Rapidglieder, CE-geprüft und markiert. Im 10er Pack erhältlich.  
Original maillon rapide, CE-certified and marked. Available in packs of 10 pcs.

ART.NO.	MATERIAL & FINISH	DIAMETER	STRENGTH	P.U.
RG07.10	stainless steel	7 mm G0	40 kN	10 pcs.
RG08.10	steel zinc-plated	8 mm	35 kN	10 pcs.
RG10.10	steel zinc-plated	10 mm	55 kN	10 pcs.
RG10I.10	stainless steel	10 mm	90 kN	10 pcs.

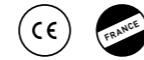

## NITRO Anti-Theft

Diebstahlsicherung. Wird zwischen Karabiner und Rapidglied gesteckt und verhindert unlauteres Entfernen. Im 10er Pack erhältlich. Theft protection. Is placed inbetween carabiner and maillon rapide. Available in packs of 10 pcs.

ART.NO.	MATERIAL	FEATURES	P.U.
ZS00KS-10	polymer	theft protection	10 pcs.



>> carabiners not included <<



# RIGGING PLATTEN

## RIGGING PLATES

### RIG IT

RIG-IT Rigging Platten sind ein hilfreiches Tool bei allen Rigging-Aufgaben, von der einfachen Konfiguration bis hin zu superkomplexen Aufbauten, zum Beispiel im Stunt Rigging oder im Rettungsbereich. Sie bieten ausreichend Platz für das Handling von mehreren Anschlagpunkten und verschiedensten Seilaufbauten. Die textilfreundlichen Radien an den Kanten schonen nicht nur dein Material, sondern ermöglichen auch die direkte Befestigung von textilen Elementen. RIG-IT rigging plates are great for any rigging work, from simple configurations to super complex setups such as stunt rigging or rescue applications. They have space for multiple anchor points and various rope setups. Special textile-friendly radii at the edges protect your gear and allow you to directly attach textile elements.



### RIG-IT seven2eight L

Die große RIG-IT seven2eight verfügt über eine besonders großzügige zentrale Öse, die speziell für die Verwendung von dicken Schlingen konzipiert ist und eine mühelose Zentralisierung der Verbindungen ermöglicht. Karabiner mit großen Verschlussgehäusen, wie der RONDO Slide Autolock, lassen sich problemlos um 360° drehen. Dies gilt für alle Öffnungen. Mit beeindruckenden 60 kN Bruchkraft und individueller ID-Nummer, um die Rückverfolgbarkeit zu gewährleisten. Our large RIG-IT seven2eight rigging plate features a very generous centralized connection point specially designed for use with thick slings. It allows you to keep all connections in one place. Carabiners with large locking sleeves, such as the RONDO Slide Autolock, can be easily rotated 360° in all the openings. Austrianpin guarantees an impressive 60 kN strength for all our rigging plates. This gives you the safety you need. Each rigging plate has an ID number to ensure traceability.



ART.NO.	MATERIAL & FINISH	FEATURES
AR08B-Y+L	● yellow, anodized	laser marking with ID number
AR08B-M+L	● matte black, anodized	laser marking with ID number

### RIG-IT three2five M

Die mittelgroße RIG-IT three2five verfügt über eine besonders großzügige zentrale Öse, die speziell für die Verwendung von dicken Schlingen konzipiert ist und eine mühelose Zentralisierung der Verbindungen ermöglicht. Karabiner mit großen Verschlussgehäusen, wie der RONDO Slide Autolock, lassen sich problemlos um 360° drehen. Dies gilt für alle Öffnungen. Die beeindruckende Festigkeit von 60 kN ist bei allen Austrianpin Rigging Platten garantiert und sorgt für die Sicherheit, die du benötigst. Jede Rigging Platte besitzt zudem eine individuelle ID-Nummer, um die Rückverfolgbarkeit zu gewährleisten. Our middle-sized RIG-IT three2five rigging plate features a very generous centralized connection point specially designed for use with thick slings. It allows you to keep all connections in one place. Carabiners with large locking sleeves, such as the RONDO Slide Autolock, can be easily rotated 360° in all the openings. Austrianpin guarantees an impressive 60 kN strength for all our rigging plates. This gives you the safety you need. Each rigging plate has an ID number to ensure traceability.



ART.NO.	MATERIAL & FINISH	FEATURES
AR05B-D+L	● blue, anodized	laser marking with ID number
AR05B-M+L	● matte black, anodized	laser marking with ID number

### RIG-IT one2three S

Die kompakte RIG-IT one2three Rigging Platte verfügt über eine besonders großzügige zentrale Öse, die speziell für die Verwendung von dicken Schlingen konzipiert ist und eine mühelose Zentralisierung der Verbindungen ermöglicht. Karabiner mit großen Verschlussgehäusen, wie der RONDO Slide Autolock, lassen sich problemlos um 360° drehen. Dies gilt für alle Öffnungen. Die beeindruckende Festigkeit von 60 kN ist bei allen Austrianpin Rigging Platten garantiert und sorgt für die Sicherheit, die du benötigst. Jede Rigging Platte besitzt zudem eine individuelle ID-Nummer, um die Rückverfolgbarkeit zu gewährleisten. Our compact RIG-IT one2three rigging plate features a very generous centralized connection point specially designed for use with thick slings. It allows you to keep all connections in one place. Carabiners with large locking sleeves, such as the RONDO Slide Autolock, can be easily rotated 360° in all the openings. Austrianpin guarantees an impressive 60 kN strength for all our rigging plates. This gives you the safety you need. Each rigging plate has an ID number to ensure traceability.

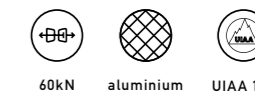

ART.NO.	MATERIAL & FINISH	FEATURES
AR03B-R+L	● yellow, anodized	laser marking with ID number
AR03B-M+L	● matte black, anodized	laser marking with ID number

# SORTIMENTS AUSZUG

## REEPSCHNÜRE UND SCHLINGEN

### CORDS AND SLINGS EXTRACT



#### DYNA.MIT Dyneema Cord

Innovatives Set für Alpinisten, bestehend aus 4 unterschiedlich langen Reepschnüren in Kern-Mantel-Konstruktion und 4 farblich dazu passenden OVALO GI Schraubkarabinern mit roter Karabiner-Offen-Markierung und individueller Nummerierung. Erleichtert das Handling am Berg. A mountaineering set comprised of 4 cords in different lengths with dyneema core, each with an OVALO GI locking carabiner with a red visual safety band and a unique identification number. The OVALO GI carabiners come in the matching color, simplifying material handling in the mountains.

- + Extrahohe Festigkeit der Reepschnur von 22 kN im Einzelstrang.
- + Vereint die besten Eigenschaften der vernähten Bandschlinge (universelle Einsetzbarkeit und hohe Festigkeit) und der Reepschnur (problemlos steckbar, in der Länge anpassbar und knotbar, kaum Feuchtigkeitsaufnahme).
- + Erleichtert die Materialauswahl für Hochtouren und alpines Gelände und sorgt mit dem Farbkonzept Blau, Grau, Rot, Schwarz für Klarheit am Standplatz und bei der Materialübergabe.
- + Erleichtert den Aufbau und die Übersicht bei Rettungstechniken.
- + Problemloses, übersichtliches Tragen um den Körper durch perfekt angepasste Längen und abgestimmte Farben.
- + Die auf 5 cm vernähten Enden verhindern ein Herausrutschen des Knotens sowie eine Mantelverschiebung und eignen sich ideal zum Stecken und Verlängern.
- + Extra high breaking strength of 22 kN (single strand).
- + 6 mm diameter cord with dyneema-core and polyester sheath combined for optimal performance of a sewn sling (universal functionality) and cord (can be knotted without difficulty).
- + The color concept blue, grey, red, black facilitates material handling, organizes the belay, makes trading off material easy and clarifies the setup of rescue systems.
- + The adjusted lengths allow you to select what you want as quickly as possible (black: simple, red/grey: double, blue: triple).
- + The ends are sewn at 5 cm to minimize slipping of the sheath due to correct knot placement.

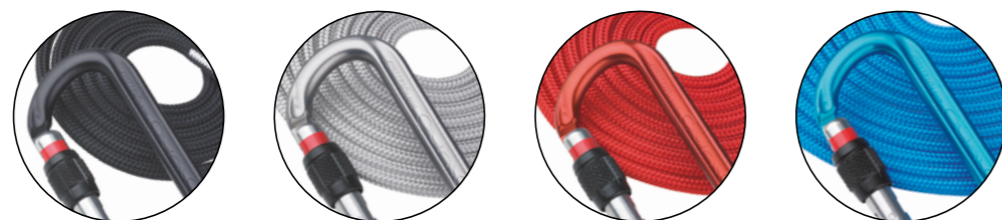

ART.NO.	MATERIAL	LENGTH	FEATURES	WEIGHT
ZS04RY-SET	● core: dyneema, sheath: PES, carabiner: aluminium	170/290/290/530 cm	set of 4 cords & 4 carabiners	606 g
ZS17RY-Z	● core: dyneema, sheath: PES	170 cm single strand		46 g
ZS29RY-G	● core: dyneema, sheath: PES	290 cm single strand		74 g
ZS29RY-R	● core: dyneema, sheath: PES	290 cm single strand		74 g
ZS53RY-B	● core: dyneema, sheath: PES	530 cm single strand		135 g

>> single cords do not include carabiners <<

#### TECH. SPECS. | OVALO GI

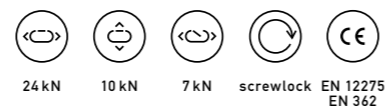

#### TECH. SPECS. | CORD



photocredit: Josef Wittbschlager



# FASHION



## COBRA T-Shirt

Das originale AUSTRIALPIN COBRA® T-Shirt: Ein Must-Have für all jene, die auf die stärkste Schnalle der Welt vertrauen! Dieses Oeko-Tex T-Shirt ist zu 100 % aus Baumwolle – für ein gutes Gefühl auf der Haut. Der kultige COBRA® Logo-Druck und kleine Details wie das Markenetikett am Saum machen dieses T-Shirt zu einem hochwertigen Begleiter – made in Europe! Regular Fit. The original AUSTRIALPIN COBRA® t-shirt: A must-have for all who put their trust in the world's strongest buckle! This Oeko-Tex t-shirt is made of 100 % cotton for a good feeling on the skin. The iconic COBRA® logo print and little details like the brand label on the hem make this t-shirt a top-quality companion – made in Europe! Regular Fit.



BRAND LOGO

ART.NO.	MATERIAL	SIZE	FEATURES
ZC10EZ-S	● 100 % cotton	S	brand logo on seam
ZC10EZ-M	● 100 % cotton	M	brand logo on seam
ZC10EZ-L	● 100 % cotton	L	brand logo on seam
ZC10EZ-XL	● 100 % cotton	XL	brand logo on seam



## COBRA Patch

Das Original COBRA® Wappen mit Klett.  
Original COBRA® patch with velcro.

ART.NO.	MATERIAL	FEATURES
ZC02	● textile	velcro back



## Loden Belt COBRA® 38

Schon mal 18kN Zug gehalten? Eine Raumstation mit Nachschub versorgt? Weltrekorde in der Stratosphäre gebrochen? Oder als Hollywood Requisite gefeiert worden? Die COBRA®, stärkste & sicherste Schnalle weltweit, übernimmt überall dort tragende Rollen, wo du es nicht erwarten würdest. Jetzt gibt es das kleine Stück Aluminium, stolz entwickelt und zu 100 % gefertigt in Tirol, als Fashion Accessoire am hochwertigen Ledergürtel in Lodenoptik. Erfahre mehr über die COBRA® und ihre vielfältigen Einsatzbereiche: Already held 18kN? Helped resupplying a space station? Broken world records in the stratosphere? No stranger to the spotlight in Hollywood? The COBRA® Quick Release, the world's strongest and safest buckle, takes on important roles in places you wouldn't expect. This little piece of aluminium, proudly developed, designed, and manufactured in Tirol, is now available as a fashion accessory on a high-end leather belt with loden look. Learn more about the AUSTRIALPIN COBRA® and its wide range of use.



#AUSTRIALPINCOBRA

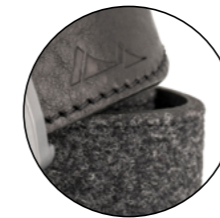

ART.NO.	BUCKLE & BELT	SIZE	MIN.	WAIST
BL80FM	● alu anodized ● leather	XS	70 cm	80 cm
BL90FM	● alu anodized ● leather	S	80 cm	90 cm
BL100FM	● alu anodized ● leather	M	90 cm	100 cm
BL110FM	● alu anodized ● leather	L	100 cm	110 cm



buckle

belt strap



## Loden Belt COBRA® 38

Technology meets fashion. Ledergürtel in Lodenoptik mit original COBRA® Schnalle.  
Technology meets fashion. Genuine leather belt with loden look and original COBRA® buckle.

ART.NO.	BUCKLE & BELT	SIZE	MIN.	WAIST
BL80MM	● alu anodized ● leather	XS	70 cm	80 cm
BL90MM	● alu anodized ● leather	S	80 cm	90 cm
BL110MM	● alu anodized ● leather	L	100 cm	110 cm



buckle

belt strap



## Leather Belt COBRA® 38

Technology meets fashion. Gürtel aus schwarzem Echtleder mit original COBRA® Schnalle.  
Technology meets fashion. Black genuine leather belt with original COBRA® buckle.

ART.NO.	BUCKLE & BELT	SIZE	MIN.	WAIST
BC80BX	● alu anodized ● leather	XS	70 cm	80 cm
BC90BX	● alu anodized ● leather	S	80 cm	90 cm
BC100BX	● alu anodized ● leather	M	90 cm	100 cm



buckle

belt strap





## Textile Belt COBRA® 38

Technology meets fashion. Hochwertiger Textilgürtel mit Topo-Design, hochwertigen Lederdetails und original COBRA® Schnalle. Technology meets fashion. High-end textile belt with topo design, high-quality leather patches and original COBRA® buckle.

ART.NO.	BUCKLE & BELT	SIZE	MIN.	WAIST
BT80EF	● alu HPC ● textile	XS	70 cm	80 cm
BT90EF	● alu HPC ● textile	S	80 cm	90 cm
BT100EF	● alu HPC ● textile	M	90 cm	100 cm
BT110EF	● alu HPC ● textile	L	100 cm	110 cm
BT120EF	● alu HPC ● textile	XL	110 cm	120 cm



buckle belt strap



## Textile Belt COBRA® 38

Technology meets fashion. Hochwertiger Textilgürtel mit Topo-Design, hochwertigen Lederdetails und original COBRA® Schnalle. Technology meets fashion. High-end textile belt with topo design, high-quality leather patches and original COBRA® buckle.

ART.NO.	BUCKLE & BELT	SIZE	MIN.	WAIST
BT80MX	● alu anodized ● textile	XS	70 cm	80 cm
BT90MX	● alu anodized ● textile	S	80 cm	90 cm
BT100MX	● alu anodized ● textile	M	90 cm	100 cm
BT110MX	● alu anodized ● textile	L	100 cm	110 cm
BT120MX	● alu anodized ● textile	XL	110 cm	120 cm



buckle belt strap



## Textile Belt COBRA® 38

Technology meets fashion. Hochwertiger Textilgürtel mit Topo-Design, hochwertigen Lederdetails und original COBRA® Schnalle. Technology meets fashion. High-end textile belt with topo design, high-quality leather patches and original COBRA® buckle.

ART.NO.	BUCKLE & BELT	SIZE	MIN.	WAIST
BT80EP	● alu HPC ● textile	XS	70 cm	80 cm
BT90EP	● alu HPC ● textile	S	80 cm	90 cm
BT100EP	● alu HPC ● textile	M	90 cm	100 cm
BT110EP	● alu HPC ● textile	L	100 cm	110 cm
BT120EP	● alu HPC ● textile	XL	110 cm	120 cm



buckle belt strap



## Textile Stretch Belt COBRAFRAME 38

Komfortabler Gürtel aus stretchfähigem Webband und COBRAFRAME Rückfädelschnalle. Comfortable textile belt made of stretch textile with COBRAFRAME thread back buckle.

ART.NO.	BUCKLE & BELT	SIZE	MIN.	WAIST
BS80YY	● alu anodized ● textile	XS	70 cm	80 cm
BS90YY	● alu anodized ● textile	S	80 cm	90 cm
BS100YY	● alu anodized ● textile	M	90 cm	100 cm



buckle belt strap

## Textile Belt COBRAFRAME 38

Gürtel aus terrakotta-farbigem Webband und schwarzer COBRAFRAME Rückfädelschnalle. Terracotta colored textile belt with black COBRAFRAME thread back buckle.

ART.NO.	BUCKLE & BELT	SIZE	MIN.	WAIST
BF80KS	● alu ktl ● textile	XS	70 cm	80 cm
BF90KS	● alu ktl ● textile	S	80 cm	90 cm
BF100KS	● alu ktl ● textile	M	90 cm	100 cm



buckle belt strap



## Textile Belt COBRAFRAME 38

Gürtel aus knallig blauem Webband und schwarzer COBRAFRAME Rückfädelschnalle. Light blue colored textile belt with black COBRAFRAME thread back buckle.

ART.NO.	BUCKLE & BELT	SIZE	MIN.	WAIST
BF80KB	● alu ktl ● textile	XS	70 cm	80 cm
BF90KB	● alu ktl ● textile	S	80 cm	90 cm
BF100KB	● alu ktl ● textile	M	90 cm	100 cm
BF110KB	● alu ktl ● textile	L	100 cm	110 cm



buckle belt strap



## Textile Belt COBRAFRAME 38

Gürtel aus schwarzem Webband und schwarzer COBRAFRAME Rückfädelschnalle. Black colored textile belt with black COBRAFRAME thread back buckle.

ART.NO.	BUCKLE & BELT	SIZE	MIN.	WAIST
BF80KM	● alu ktl ● textile	XS	70 cm	80 cm
BF90KM	● alu ktl ● textile	S	80 cm	90 cm
BF100KM	● alu ktl ● textile	M	90 cm	100 cm
BF110KM	● alu ktl ● textile	L	100 cm	110 cm
BF120KM	● alu ktl ● textile	XL	110 cm	120 cm



buckle belt strap



## Textile Belt COBRAFRAME 38

Gürtel aus kiwi-grünem Webband und schwarzer COBRAFRAME Rückfädelschnalle. Kiwi-green colored textile belt with black COBRAFRAME thread back buckle.

ART.NO.	BUCKLE & BELT	SIZE	MIN.	WAIST
BF80KN	● alu ktl ● textile	XS	70 cm	80 cm
BF90KN	● alu ktl ● textile	S	80 cm	90 cm
BF100KN	● alu ktl ● textile	M	90 cm	100 cm



buckle belt strap





photocredit: AUSTRIALPIN

# DISCOVER EVEN MORE PRODUCTS!



DOWNLOAD NOW!

+ [austrialpin.at](http://austrialpin.at)

Unseren Katalog mit allen Sport- und Sicherheitsprodukten findest du online zum Download! Download our catalog with all sports and safety products online!





photocredit: Peter Manhartsberger



photocredit: Peter Manhartsberger



photocredit: Peter Manhartsberger



photocredit: Peter Manhartsberger



MADE IN AUSTRIA

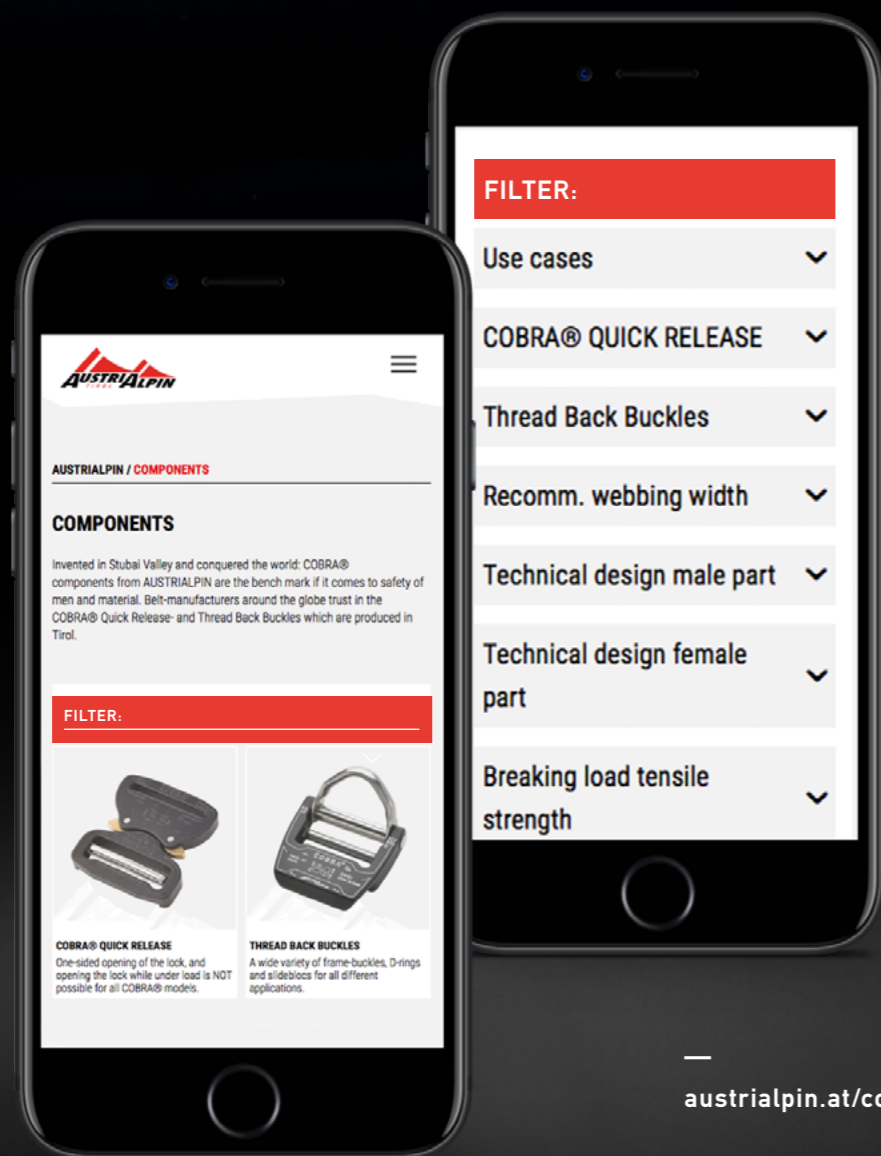

— [austrialpin.at/components](https://austrialpin.at/components)

Mit den Filteroptionen auf unserer Website gelangst du direkt zur Komponente deiner Wahl.

Have a look at our website and use the web content filter to choose your favourite component.

— Die gesamte AUSTRIALPIN Palette an Produkten und Komponenten findest du auf unserer Website.

Find the complete AUSTRIALPIN product and component range on our website.

Owner, editor and publisher  
AUSTRIALPIN GmbH

Concept and realisation  
© Bureau Rabensteiner

Product photography  
Fred Einkemmer, Mike Rabensteiner

Text  
AUSTRIALPIN & Julia Enghart

VERY SPECIAL THANKS to our team athletes, photographers, business partners and everyone else who is, in one way or the other, part of the AUSTRIALPIN family!

All data are subject to change and are provided without any guarantee. Printing and layout errors excepted.

HEAD OFFICE  
AUSTRIALPIN GmbH  
Industriezone C2a  
6166 Fulpmes | Austria

T +43 5225 652 48 0  
F +43 5225 652 48 2  
[office@austrialpin.at](mailto:office@austrialpin.at)

[www.austrialpin.at](https://www.austrialpin.at)



---

**HEAD OFFICE**

AUSTRIALPIN GmbH  
Industriezone C2a  
6166 Fulpmes | Austria  
T +43 5225 652 48 0  
F +43 5225 652 48 2  
office@austrialpin.at  
www.austrialpin.at

---

**Finest manufactured  
PPE safety hardware**

---

**Made in Tirol  
Austria**

---

**2024**